

**SMT-BD1/p
CD1-p**

gb

**PROFIBUS
POSITIONER
User manual**

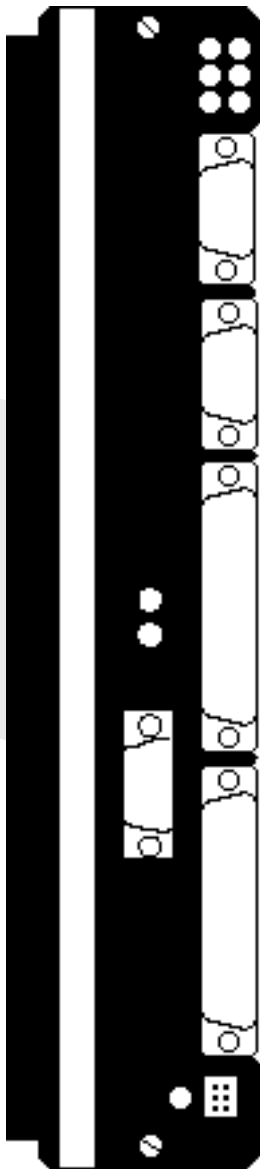

INFRANOR®



WARNING !



This is a general manual describing a series of servo amplifiers having output capability suitable for driving AC brushless sinusoidal servo motors. This manual may be used in conjunction with appropriate and referenced drawings pertaining to the various specific models.

Instructions for storage, use after storage, commissioning as well as all technical details require the MANDATORY reading of the manual before getting the amplifiers operational.

Maintenance procedures should be attempted only by highly skilled technicians having good knowledge of electronics and servo systems with variable speed (EN 60204-1 standard) and using proper test equipment.

The conformity with the standards and the "CE" approval is only valid if the items are installed according to the recommendations of the amplifier manuals. Connections are the user's responsibility if recommendations and drawings requirements are not met.



Any contact with electrical parts, even after power down, may involve physical damage. Wait for at least 5 minutes after power down before handling the amplifiers (a residual voltage of several hundreds of volts may remain during a few minutes).



ESD INFORMATION (ElectroStatic Discharge)

INFRANOR amplifiers are conceived to be best protected against electrostatic discharges. However, some components are particularly sensitive and may be damaged if the amplifiers are not properly stored and handled.

STORAGE

- The amplifiers must be stored in their original package.
- When taken out of their package, they must be stored positioned on one of their flat metal surfaces and on a dissipating or electrostatically neutral support.
- Avoid any contact between the amplifier connectors and material with electrostatic potential (plastic film, polyester, carpet...).

HANDLING

- If no protection equipment is available (dissipating shoes or bracelets), the amplifiers must be handled via their metal housing.
- Never get in contact with the connectors



ELIMINATION

In order to comply with the 2002/96/EC directive of the European Parliament and of the Council of 27 January 2003 on waste electrical and electronic equipment (WEEE), all INFRANOR devices have got a sticker symbolizing a crossed-out wheel dustbin as shown in Appendix IV of the 2002/96/EC Directive.

This symbol indicates that INFRANOR devices must be eliminated by selective disposal and not with standard waste.

INFRANOR does not assume any responsibility for any physical or material damage due to improper handling or wrong descriptions of the ordered items.

Any intervention on the items, which is not specified in the manual, will immediately cancel the warranty.

Infranor reserves the right to change any information contained in this manual without notice.

© INFRANOR, October 2005. All rights reserved.
Edition: 2.4

Windows® is a registered trade-mark of MICROSOFT® CORPORATION.

STEP7® is a registered trade-mark of SIEMENS®.

Contents

	PAGE
CONTENTS.....	5
CHAPTER 1 - GENERAL DESCRIPTION	7
1 - INTRODUCTION.....	7
2 - ARCHITECTURE OF A POSITIONER.....	8
CHAPTER 2 - COMMISSIONING.....	9
1 - CHECKING THE POSITIONER HARDWARE CONFIGURATION.....	10
2 - PUTTING INTO OPERATION.....	10
3 - MOTOR ADJUSTMENT.....	10
3.1 - Motor parameter setting.....	10
3.2 - Current loops (CD1-p).....	10
3.3 - Adjustment to a new motor.....	11
3.4 - I ² t protection (BD1p).....	11
3.5 - I ² t protection (CD1p).....	13
3.6 - Rotation/counting direction.....	14
3.7 - Maximum application speed.....	14
3.8 - Thermal sensor configuration on the CD1-p positioner.....	14
4 - SERVO CONTROL ADJUSTMENT.....	14
4.1 - Regulator parameters.....	14
4.2 - Regulator adjustment with vertical load.....	15
4.3 - Enabling.....	15
4.4 - Brake control.....	15
4.5 - Limit switches adjustment.....	15
5 - CONFIGURATION.....	16
5.1 - General parameters.....	16
5.2 - Manual motion parameters.....	16
5.3 - Scale parameters.....	17
5.4 - Encoder output parameters (SMT-BD1/p only).....	18
6 - PROFIBUS ADDRESS.....	18
7 - PARAMETERS SAVING.....	18
8 - PROFIBUS COMMUNICATION.....	19
8.1 - PPO message.....	19
8.2 - Configuration.....	21
8.3 - Parameter setting (PKW).....	21
8.4 - Global control.....	23
CHAPTER 3 - PROGRAMMATION.....	24
1 - GENERAL DESCRIPTION.....	24
2 - EDITION OF A SEQUENCE.....	24
2.1 - Motion sequence.....	25
2.2 - Homing sequence.....	25
2.3 - Speed sequence.....	26
2.4 - Torque sequence (on CD1p, and from EPROM version 507.18 on BD1p).....	27
2.5 - Sequence control.....	27
2.6 - Logic outputs (virtual).....	29
CHAPTER 4 - OPERATION	30
1 - COMMUNICATION.....	30
1.1 - Control word.....	30
1.2 - Input command.....	30
1.3 - Status.....	31
1.4 - Feedback.....	31
2 - OPERATION DIAGRAM.....	32

2.1 - Positioner control process	32
2.2 -Positioning mode	33
3 -DRIVING OF THE POSITIONER	34
3.1 -Enabling/disabling.....	34
3.2 -Starting a sequence.....	34
3.3 -Other movements	34
3.4 -Speed control.....	34
CHAPTER 5 - PARAMETER SETTING BY PROFIBUS.....	35
1 -PARAMETER LIST	35
2 -PARAMETERS DESCRIPTION	37
2.1 - Motor parameters.....	37
2.2 -Current parameters.....	38
2.2 -Current parameters.....	38
2.3 -Application parameters	39
2.4 -Regulator parameters	40
2.5 -Positioner parameters.....	42
2.6 -Encoder output.....	43
2.7 -Options.....	44
2.8 -Manual motion parameters.....	44
2.9 -Sequence Reading/Writing	47
CHAPTER 6 – FAULT FINDING.....	53
1 - DIAGNOSTICS	53
1.1 - SMT-BD1/p fault LEDs	53
1.2 - CD1-p fault LEDs.....	53
1.3 -Fault reset.....	54
2 -FAULT FINDING	54
2.1 -System fault	54
2.2 -Non stored faults.....	54
2.3 -Stored faults.....	54
3 -OPERATING PROBLEMS	56
3.1 -Motor does not move	56
3.2 -Motor supplied but no torque.....	56
3.3 -Shaft locked, erratic oscillations or rotation at maximum speed.....	56
3.4 -Discontinuous motor rotation with zero torque positions.....	56
3.5 -Loud crackling noise in the motor at standstill.....	56
3.6 -Loud noise in the motor at standstill and when running	56
3.7 -Sequence not executed	56
4 - SERVICE AND MAINTENANCE	56
APPENDIX	57
1 -CURRENT LOOPS ADJUSTMENT (SMT-BD1/P)	57

Chapter 1 - General description

1 - INTRODUCTION

INFRANOR® Profibus positioners are digital PWM servo amplifiers that provide motion servo control for AC sinusoidal motors (brushless) with transmitter resolver.

2 series are available:

- the plug-in **SMT-BD1/p** series is available as a single-axis block version or as a multi-axis version that can receive up to six axes in a standard 19" rack. Both versions are including a power supply unit.
- the **CD1-p** series is a small-sized and low current single-axis version.

Both **SMT-BD1/p** and **CD1-p** are operating with a PROFIBUS-DP interface; so, driving and parameter setting can both be entirely made by the bus. The specific software of the INFRANOR® Profibus positioners, that can be installed on a laptop, makes the positioner parameter setting easy, thanks to the serial RS-232 link.

These drives have got the positioner function: 128 positioning movements, homing and speed profile can be programmed or combined. The control simply consists in selecting one of these movements.

This manual is composed of 6 chapters:

1 - General description	
2 - Commissioning	First commissioning of the positioner
3 - Programming	Movement programming (also called "sequence")
4 - Operation	Enabling/disabling and control by Profibus
5 - Parameter setting by Profibus	Parameters list accessible via Profibus
6 - Fault finding	Diagnostics and fault elimination

For the hardware drive installation (dimensions, wiring...) see [the various manuals pertaining to each positioner \(SMT-BD1/p – Installation and CD1-p – Installation\)](#).

2 - ARCHITECTURE OF A POSITIONER

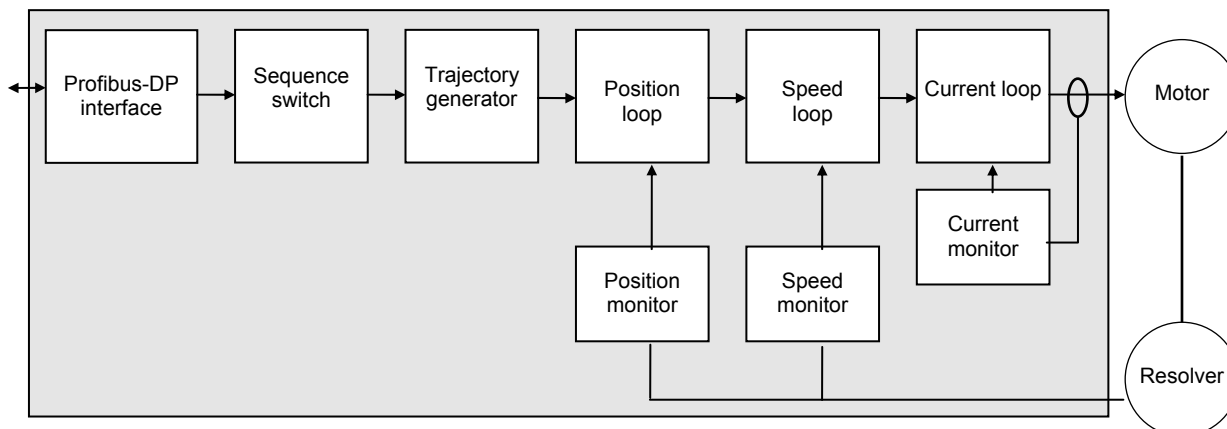

Electric motor	Electric device that transforms electrical energy into a mechanical movement. This transformation is often made by means of current commutation. Generally, the movement is a rotation but there are also linear motors.
Motor	Electric motor which current commutation is made by mechanical brushes.
Brushless or synchronous motor	Electric brushless motor. The current commutation is electronically made and requires a position sensor (resolver, encoder, Hall sensor...).
Resolver	Absolute position sensor over one revolution. Resolvers are often used on brushless motors.
Positioner	Electric device for the control of electric motors. It also includes a current regulator, a speed servo control and, sometimes, a position servo control.
Current loop Current regulator	Used for the motor current control. The motor torque is generally proportional to the current amplitude.
Speed loop Speed regulator	Allows the motor speed control with a speed input command.
Position loop Position regulator	Allows the motor position control.
Positioner	Positioner with position loop and trajectory generator that allows positioning.
Trajectory generator	Generates a speed profile (acceleration, step speed, deceleration) that allows positioning (start position -> arrival position).
Field bus	Digital link that allows real time data exchange between various electric devices. The characteristic of field busses is their high protection and fault correction level as well as a predictable communication time.
Profibus	Fieldbus initially defined by Siemens®. This bus is widely used in automation.
Enabled/disabled (<i>Servo On/Off</i>)	When a motor is enabled, it is controlled by the positioner and the servo loops are operating. When it is disabled, its rotation is free and there is no current in the motor.

Chapter 2 - Commissioning



WARNING

During the machine adjustments, some drive connection or parameter setting errors may involve dangerous axis movements. It is the user's responsibility to take all necessary steps in order to reduce the risk due to uncontrolled axis movements during the operator's presence in the concerned area.

The various stages of a first positioner commissioning are described below:

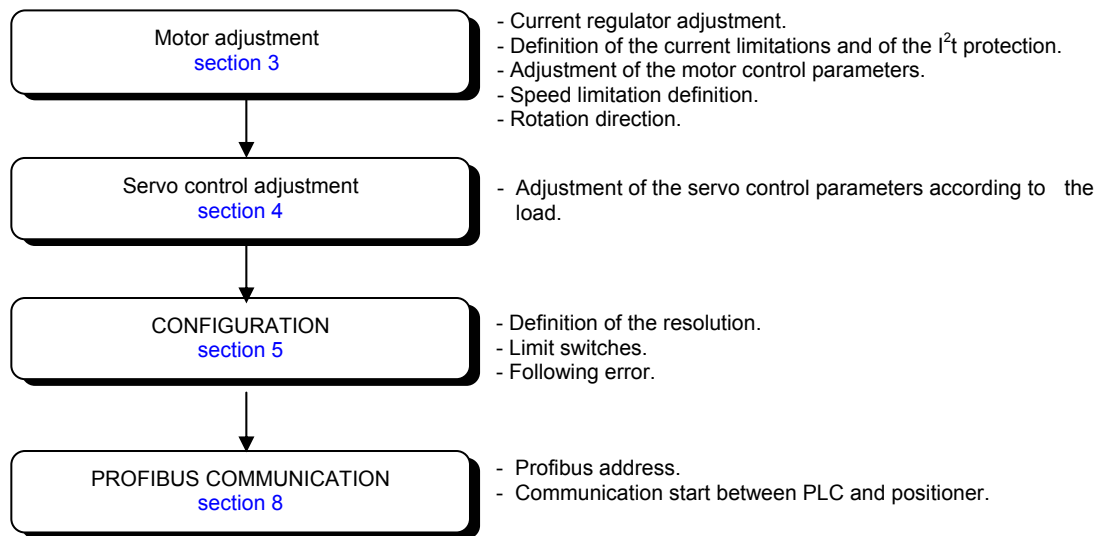

Both operation stages are:

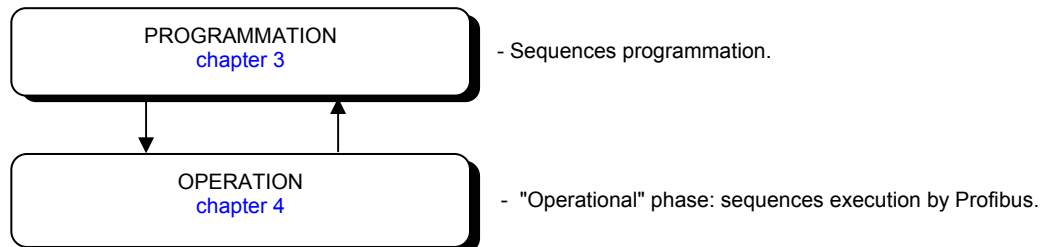

The positioner parameters are accessible via:

- the serial link and the PC parameter setting software,
- or by the PKW of the PROFIBUS DP.

CAUTION !

Do not make the drive parameter setting by means of both PC software and Profibus at the same time.

INSTALLATION AND USE OF THE PC SOFTWARE

The **Visual Drive Setup** software is PC compliant under Windows^{®1} and allows an easy parameter setting of the **BD1-p** and **CD1-p** amplifiers.

Please see our website www.infranor.fr for downloading the "Visual Amplifier Setup" software.

¹ Windows[®] is a registered trade mark of MICROSOFT[®] CORPORATION

1 - CHECKING THE POSITIONER HARDWARE CONFIGURATION

The positioner standard configuration for MAVILOR motors equipped with a TAMAGAWA resolver is the following:

SMT-BD1/p positioner:

- Resolver adjustment card P RES: 4 x 12,7 K Ω 1%.
- Current loops adjustment.
- Motor thermal probe PTC: Jumper MN.
- Positive control logic: Jumpers E. F. G closed.
- No auxiliary supply: Jumper JK closed and jumper KL open.
- SW1 "OFF" on all switches.

CD1-p positioner:

- Resolver P RES adjustment board: 4 x 12,7 K Ω 1%.

For the positioner adjustment to other resolver types, or to another control logic, [see Installation manual](#).

2 - PUTTING INTO OPERATION

For the first positioner powering, see [installation manuals \(SMT-BD1/p Installation and CD1-p Installation\)](#).

The logic voltage (auxiliary supply on the SMT-BD1/p and 24 V on the CD1-p) must be applied to the positioner before the power voltage.

CAUTION !

When turning off the positioner, wait for at least 5 seconds before turning power on again.

3 - MOTOR ADJUSTMENT

3.1 - Motor parameter setting

Select the positioner and fan types required for the motor used.

Select the positioner current limitation mode. The "Fusing" mode is recommended for the commissioning phases.

In "Fusing" mode, the positioner is disabled when the current limitation threshold is reached.

In "Limiting" mode, the current is only limited at the value defined by the **Rated current** parameter when the limitation threshold is reached.

The parameter **Max. current** defines the maximum current value supplied by the positioner. It can vary between 20 % and 100 % of the positioner current rating. This parameter is defined according to the positioner and motor specifications.

The **Rated current** parameter defines the limitation threshold of the RMS current (I^2t) supplied by the positioner. It can vary between 20 % and 50 % of the positioner current rating. This threshold is set according to the positioner and motor specifications.

Check that the values of the **Maximum current** and **Rated current** parameters are complying with motor and positioner. Otherwise, modify them according to the appropriate motor and positioner specifications.

The **Max. speed** parameter defines the maximum motor rotation speed. The speed range is between 100 and 10000 rpm and the resolution is 5 rpm. Check that its value is complying with motor and application. Otherwise, modify it according to the motor and application specifications.

3.2 - Current loops (CD1-p)

When the motor used is not contained in the motor list, the current loops gain values must be defined according to the supply voltage (230 V or 400 V), to the positioner current rating and to the motor inductance.

3.3 - Adjustment to a new motor

Uncouple the motor from the mechanical load and check that the motor shaft is free and for free rotation (1 revolution) that is not dangerous for the operator.

Execute the auto-phasing procedure (**the positioner must be disabled and the ENABLE signal must be activated**) in order to define the parameters **Number of pole pairs**, **Motor phase** and **Resolver adjustment**. Please note that during the auto-phasing procedure the motor is automatically enabled and then disabled when the procedure is over.

If the motor is equipped with a brake, unlock the brake manually before starting the procedure.

The auto-phasing procedure calculates the following parameters:

- The parameter **Number of pole pairs** defines the number of motor pole pairs.
- The parameter **Phases order** defines the motor phases order.
- The parameter **Resolver offset** defines the mechanical shift between both motor and resolver references.

Calculate the **Phase lead** parameter from the specific motor parameters (the effects of this parameter are particularly useful on low inductance motors running at high speeds)

3.4 - I²t protection (BD1p)

Current limitation in Fusing mode

When the amplifier RMS current (I²t) reaches 85 % of the **Rated current**, the Idyn signal output is activated and the I²t error display is blinking on the amplifier front panel. If the RMS current (I²t) has not dropped below 85 % of the **Rated current** within 1 second, the I²t fault is released and the amplifier is disabled (otherwise, the Idyn signal and the blinking I²t error display are both cancelled).

When the amplifier RMS current (I²t) reaches the **Rated current** value, the I²t protection limits the amplifier current at this value.

The amplifier current limitation diagram in an extreme case (motor overload or locked shaft) is shown below.

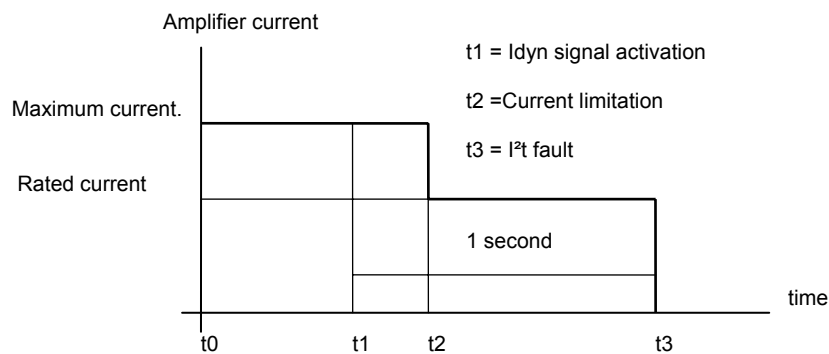

The maximum current duration before the release of the Idyn signal depends on the value of the **Rated current** and **Maximum current** parameters. This value is calculated as follows:

$$T_{\text{dyn}} (\text{second}) = t1 - t0 = 3.3 \times \left[\frac{\text{Rated current} (\%)}{\text{Maximum current} (\%)} \right]^2$$

The maximum current duration before the limitation at the rated current also depends on the value of the **Rated current** and **Maximum current** parameters. This value is calculated as follows:

$$T_{\text{max}} (\text{second}) = t2 - t0 = 4 \times \left[\frac{\text{Rated current} (\%)}{\text{Maximum current} (\%)} \right]^2$$

NOTE 1

The above formulas are valid as long as the **Maximum current / Rated current** ratio is higher than 3/2. When the **Maximum current / Rated current** ratio is close to 1, the calculated values of T_{dyn} and T_{max} are quite below the real values. For example when **Maximum current / Rated current** = 1.2, the measured T_{dyn} = 3.4 seconds and the measured T_{max} = 4.4 seconds. When the **Maximum current / Rated current** ratio is equal to 1, the I²t protection is no more disabling the amplifier but the current is limited at the **Rated current** value.

NOTE 2

The amplifier I^2t signal can be displayed on the digitizing oscilloscope by selecting the " I^2t " signal in the "Channel" menu. The I^2t signal threshold values according to the I^2t protection mode described above are calculated in the following way:

$$\begin{aligned} \text{Idyn signal activation threshold (\%)} &= [\text{Rated current (\%)}]^2 / 70 \\ \text{Current limitation threshold (\%)} &= [\text{Rated current (\%)}]^2 / 50 \end{aligned}$$

The corresponding amplifier RMS current value can be calculated according to following formula :

$$\text{Amplifier RMS current (\%)} = [I^2t \text{ signal value (\%)} \times 50]^{1/2}$$



In **Fusing mode**, the amplifier **Rated current** value must be adjusted lower or equal to the **Maximum authorized rated current** of the amplifier.

Current limitation in Limiting mode

When the amplifier RMS current (I^2t) reaches 85 % of the **Rated current**, the Idyn signal output is activated and the I^2t error display is blinking on the amplifier front panel. When the RMS current (I^2t) drops below 85 % of the **Rated current**, the Idyn signal and the blinking I^2t error display are both cancelled.

When the amplifier RMS current (I^2t) reaches the **Rated current** value, the I^2t protection limits the positionner current at this value.

The amplifier current limitation diagram in an extreme case (motor overload or locked shaft) is shown below.

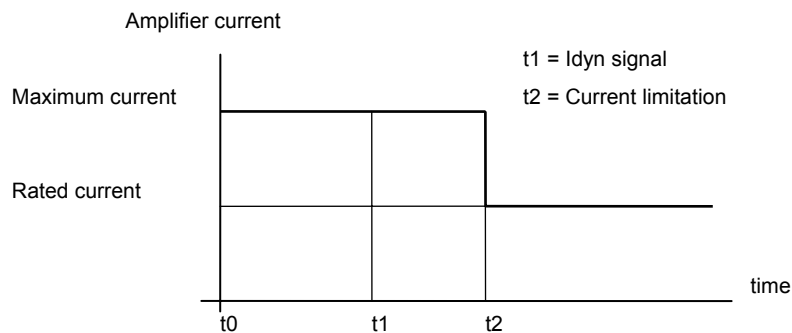

The maximum current duration before the release of the Idyn signal output ($t_1 - t_0$) and before limitation at the rated current ($t_2 - t_0$) is calculated the same way as for the **Fusing mode**.

The I^2t signal threshold values and the amplifier RMS current value on the digitizing oscilloscope, are also calculated the same way as for the **Fusing mode**.



In **Limiting mode**, the amplifier **Rated current** value must be adjusted lower or equal to the **Maximum authorized continuous current** of the amplifier.

3.5 - I²t protection (CD1p)

Current limitation in **Fusing** mode

If the RMS current as not dropped below 85 % of the **Rated current** after 1 second, the I²t fault is released and the amplifier disabled.

When the amplifier RMS current (I²t) reaches the **Rated current** value, the I²t protection limits the amplifier current at this value.

The amplifier current limitation diagram in an extreme case (motor overloaded or shaft locked) is shown below:

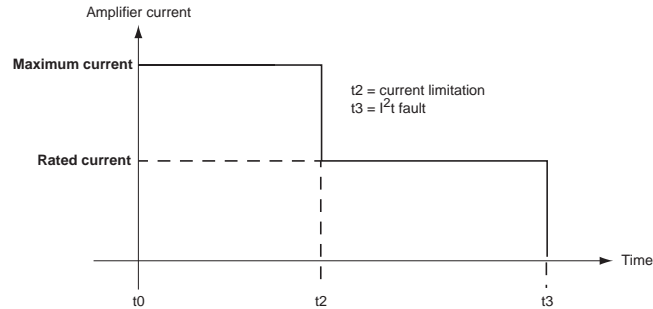

The maximum current duration before limitation at the rated current is depending on the value of the **Rated current** and **Maximum current** parameters.

$$T_{\max} (\text{second}) = (t_2 - t_0) = 4 \times [\text{Rated current (A)}]^2 / [\text{Maximum current (A)}]^2$$

The current limitation duration before the release of the protection is depending on the value of the **Rated current** and **Maximum current** parameters:

$$T_{\text{lim}} (\text{second}) = (t_3 - t_2) = 1 - 0.7 \times [\text{Rated current (A)}]^2 / [\text{Maximum current (A)}]^2$$

NOTE

- These formula are correct for a **Maximum current / Rated current** ratio > 1.5.
- When the **Maximum current / Rated current** ratio = 1, there is no interruption and the current is maintained at the rated current value.
- The I²t signal can be displayed by means of the digitizing oscilloscope available in the **Visual Drive Setup** software.

$$\text{Rated current (\%)} = 100 \times \text{Rated current (A)} / \text{Amplifier current rating (A)}$$

$$\text{Current limitation threshold (\%)} = [\text{Rated current (\%)}]^2 / 50$$

$$\text{Amplifier RMS current (Arms)} = [(\text{I}^2\text{t signal value (\%)} \times 50)^{1/2} \times \text{Amplifier current rating (A)}] / 100$$

Current limitation in **Limiting** mode

When the amplifier RMS current (I²t) reaches the **Rated current** value, the I²t protection limits the amplifier current at this value.

The amplifier current limitation diagram is shown below.

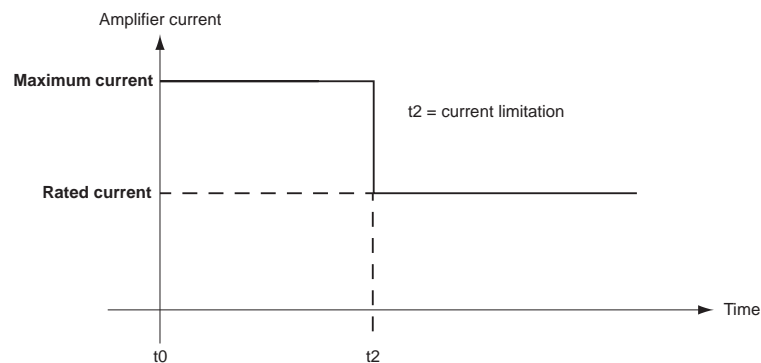

The maximum current duration before limitation at the rated current (t₂ - t₀) is calculated the same way as for the **Fusing** mode.

3.6 - Rotation/counting direction

This possibility defines the position counting direction with regard to the motor rotation direction. For the encoder position output, the counting direction remains unchanged with regard to the motor rotation direction.

On Mavilor motors, in normal rotation, the position is incrementing in the motor CW rotation direction. In reverse rotation, the position is incrementing in the motor CCW rotation direction.

3.7 - Maximum application speed

The parameter **Max. speed** defines the maximum speed with which the positioner can control the motor. This parameter must be:

- lower or equal to the max. motor speed,
- approximately 20 % higher than the maximum motor rotation speed in the application. This margin allows a speed overshooting and avoids a position loop saturation (which would involve a position following error). This margin can be smaller when the loop bandwidth is high and the accelerations low.

3.8 - Thermal sensor configuration on the CD1-p positioner

There are 2 possible sensor types that can be software configured:

PTC sensor: the triggering will occur at a value of about 3.3 kOhms of the thermal sensor resistor, that is 140°C.

NTC sensor: the triggering will occur at a value of about 3.3 kOhms of the thermal sensor resistor, that is 140°C.

4 - SERVO CONTROL ADJUSTMENT

4.1 - Regulator parameters

WARNING



The auto-tuning procedure should be executed by the PC in control mode and at standstill. If the auto-tuning procedure must be executed with the drive controlled by the analog command input CV, the value of the input command **MUST** be 0 Volt. It is the user's responsibility to take all necessary steps in order to reduce the risk due to uncontrolled axis movements during the auto-tuning procedure.

The auto-tuning procedure identifies the motor and load specifications and calculates the regulator gain parameters. During the procedure, the operator can select 1 bandwidth (Low, Medium and High) and 1 filter (standard, antiresonance and high stiffness – the last filter is only available on the CD1-p positioner). These values correspond to the cut-off frequency for a 45° speed loop phase shift.

The auto-tuning can be executed with disabled or enabled motor (i.e. vertical load), but the ENABLE signal must always be activated.

If the motor is equipped with a brake, unlock the brake manually before starting the procedure.



Check for free motor shaft rotation over one revolution, that is not dangerous for operator and machine before starting the auto-tuning with filter = standard.

After the auto-tuning procedure, check that the motor correctly runs in both directions. Check the **response for a small movement without IDC saturation**.

In case of loud noise in the motor at standstill and when running, check the rigidity of the transmission between motor and load (backlashes and elasticities in gears and couplings). If necessary, renew the auto-tuning procedure by selecting a lower bandwidth. If the problem remains, renew the auto-tuning procedure by activating the antiresonance filter.

Adjust more accurately the loop response stability by adjusting the stability gain.

4.2 - Regulator adjustment with vertical load

In the case of an axis with unbalanced load (constant torque due to a vertical load), proceed as follows:

Select the current "Limiting" mode.

Initialize the speed loop gains corresponding to the unloaded motor (run the auto-tuning procedure with the motor uncoupled from its mechanical load).

Couple the motor with the load. If possible, make a speed control; otherwise, close the position loop with a stable gain.



Move the shaft by means of the speed input command until a maintaining position where one motor revolution is not dangerous for operator and machine (far enough from the mechanical limit stops).

Run the auto-tuning function with motor at standstill. If the motor shaft is moving, the auto-tuning has not been accepted by the positioner.

4.3 - Enabling

The enabling can be made:

- by Profibus (see operation diagram for the enabling procedure in chapter 4, section 2.1) or
- by the PC parameter setting software.

4.4 - Brake control

- The SMT-BD1/p positioner is equipped with a brake control signal.
This brake control signal is low powered and cannot directly control the brake. The BMM 05 AF single-axis rack is therefore equipped with a power relay that allows the brake control (the multiaxes rack is not equipped with this relay).
- The CD1-p positioner is equipped with a brake control (made by transistor).
- The brake control is activated (relay open) or disabled (relay closed) according to the positioner status (disabled or enabled).

4.5 - Limit switches adjustment

The limit switch inputs are inputs for a proximity sensor that stops the motor with maximum deceleration. When both limit switches are correctly placed on the motor stroke, they are a protection for the machine in case of incorrect movement.

The limit switches are only defined according to the physical motor rotation. They are not depending on the selected "rotation/counting direction".

On Mavilor motors, if the option "rotation/counting direction" is normal, the FC+ input must be wired in the positive motor counting direction.

For checking the limit switches:

- move the motor in one direction,
- activate the limit switch which is located in the movement direction (artificially, if necessary),
- check that the motor is stopping,
- if the motor does not stop, the limit switches are reversed wired.

Check also in the opposite direction.

Notes

- The motor is stopped with maximum deceleration by a limit switch.
- Reminder: The limit switches are wired as "normally closed".

5 - CONFIGURATION

5.1 - General parameters

Speed profile: trapezoidal or S-curve.

Brake on delay: defines the time between the brake enabling and the positioner disabling.

- brake activation (relay open),
- delay time,
- positioner disabling.

Brake off delay: defines the time between the positioner enabling and the brake disabling:

- positioner enabling,
- delay time,
- brake disabling (relay closed).

Minimum SEQ pulse (on CD1-p and from firmware version 507.18 on BD1/p): When activated, this function defines the minimum duration of the SEQ output.

Configuration: bit 12 of PNU 742 (positioner configuration).

InPos window (on CD1-p and from firmware version 507.18 on BD1/p): When activated, this function defines the position window in which the InPos output is activated (only for a positioning). This window is equal to the arrival position +/- the programmed value.

Digital CAM (on CD1-p and from firmware version 507.18 on BD1/p): When activated, this function activates the logic output OUT1 (bit 0 of the virtual outputs) when the motor passes an area defined by positions P1 and P2.

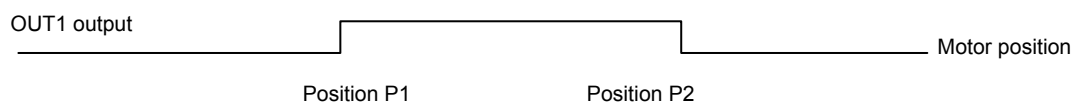

Configuration: bit 14 of PNU 742 (positioner configuration).

Position value (32 bits): PNU 758 and PNU 759.

5.2 - Manual motion parameters

There are 2 types of manual motion:

- basic positioning: moving of the motor until a given position directly by the operator.
- jog: continuous movement when the jog signal is activated (JOG+ for a movement in the positive direction and JOG- for a movement in the negative direction).

The motion profile parameters are:

- "motion speed",
- "acceleration time",
- "deceleration time"

These three parameters can be independently adjusted for a Jog or a Positioning.

The parameters "acceleration time" and "deceleration time" define the time with regard to the max. speed (defined by the parameter "Speed limitation"). When the motion speed is lower than the maximum speed, the trajectory acceleration and deceleration times are proportionally smaller.

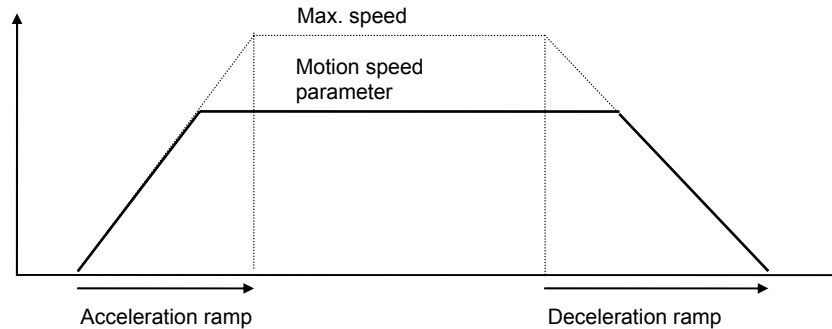

NOTE: Concerns only the positioning sequences.

5.3 - Scale parameters

Position resolution: defines the position resolution for one motor revolution according to the number of decimals and the unit required. The adjustment range is between 16 and 65536 ppr.

Decimal number: Factor of 10 for the position resolution (1, 2 or 3).

Unit: Defines the position unit (maximum 4 characters).

Example: For a resolution of 4 mm/motor rev., if the number of decimals is 3, the parameters will be:
 Resolution = 4000, Decimal number = 3, Unit = mm.

Following error threshold: defines the following error triggering threshold.

It is important to correctly adjust this value in order to get a good protection.

It can be adjusted like follows:

- 1 - Make the motor rotate with the required operation cycles and measure the maximum following error threshold:
 - either by means of the oscilloscope of the parameter setting software,
 - or by reducing the following error threshold value until the fault is triggered,
- 2 - Then set the following error threshold at this value plus a margin of 30 to 50 %.

Example: Adjustment of the following error threshold on an axis with:

Position resolution = 5000.

Maximum following error measured by oscilloscope = 0,05 V.

The following error value is: $0,05 / 10 \times 32767 = 164$.

The threshold is set at 246 (margin = 50 %).

Note: In the PC parameter setting software, if the number of decimals is set at 3, the value that must be entered is 0,246.

Deadband: Defines the deadband for the position controller. When this parameter is set at 0, the deadband is disabled.

CLR input enable: When activated (box ticked off), this function allows the use of the INDEX input for resetting the position counter: the active/inactive transition uploads the value of the **Clear position** parameter in the position counter.

Reset counter/Modulo: This function resets the position counter as soon as it has reached the predefined position. If the value is set at 0, this function is disabled.

Forward: When the **Reset counter/Modulo** function is activated and if the **Forward** function is selected, the motor only runs in the positive direction for an absolute motion lower than the value defined by the **Reset Counter** parameter.

When the **Reset counter/Modulo** function is activated and if the **Forward** function is not selected, for an absolute motion lower than the value defined by the **Reset Counter** parameter, the motor follows the shortest way (whichever the motor rotation direction).

Software limit switches + and - (CD1p and from firmware version 507.18 on BD1p): This function is only active if a "Home" sequence has been executed before. When the motor shaft passes the limit position programmed, it is stopped with a controlled braking. The deceleration value is provided by the parameter "Jog deceleration time".

Configuration : Bit 0 of PNU 742 for the positive direction, and bit 1 of PNU 742 for the negative direction.

5.4 - Encoder output parameters (SMT-BD1/p only)

The parameter **Encoder resolution** defines the encoder resolution on channels A and B (X2 connector) of the encoder position output for one motor shaft revolution. Binary and decimal values are both accepted. The maximum encoder resolution per revolution is limited by the motor rotation speed as shown in the table below.

Max. possible speed (rpm)	900	3600	10000
Max. encoder resolution	8192	4096	1024

The parameter **Number of zero pulse** defines the number of marker pulses on channel Z for one motor shaft revolution. The adjustment range is between 1 and 16.

The parameter **Zero pulse origin shift** defines the shift between the first marker pulse on channel Z and the resolver reference position. The adjustment range is between 0 and 32 767. The value 32 767 corresponds to one motor shaft revolution.

The parameter **Zero pulse width** defines the marker pulses width on channel Z in ppr. The adjustment range is between 8 and 32 767. The value 32 767 corresponds to one motor shaft revolution.

Caution

The encoder output is not available on the CD1-p series positioners, even though these parameters are existing.

6 - PROFIBUS ADDRESS

Each positioner of the network is identified by one single address (1 to 125). The positioner is delivered with the default address 126 **which is not an operational address**. This address must be modified before putting the bus into operation.

The SMT-BD1/p or CD1-p address can be modified:

- by the serial RS-232 link (PC parameter setting software). The new address must be saved in the EEPROM and the positioner must be switched on again in order to get the new address operational;
- or by a Profibus class 2 master device. The address modification is only possible when the bus is not running. In this case, the address will be automatically saved in the positioner EEPROM and will be operational at the bus starting.

The identity number of the SMT-BD1/p and CD1-p positioners under Profibus is 0x00C7.

7 - PARAMETERS SAVING

When all adjustments are made, the parameters must be saved in the EEPROM (with disabled positioner).

8 - PROFIBUS COMMUNICATION

The Profibus communication is a master-slave communication. The INFRANOR® positioner is a slave positioner and the only important parameter to be defined for the communication is the amplifier address on the bus.

All other parameters (communication speed, configuration, parameters) are defined in the PLC (master) and will be automatically sent to the positioner:

- the available communication speeds are: 9,6 KB, 19,2 KB, 93,72 KB, 187,5 KB, 500 KB, 1,5 MB, 3 MB, 6 MB, 12 MB and will be automatically detected by the positioner.
- the configuration used will be sent to the slave at the bus starting. The available configurations are PPO1, PPO2, PPO3 or PPO4,
- default parameter setting: not used by the positioner.

These various possibilities are pre-defined in a GSD file proper to each product range running with Profibus. The file for the INFRANOR® positioner is **INFR00C7.GSD** and is available for download from the website www.infranor.fr.

When defining the network on the master, please:

- import the slave GSD file if this has not yet been done,
- create a network with the master,
- connect a slave on the network with the same address as defined in the slave.

Note: When the communication is established, the green "RUN" LED lights up.

8.1 - PPO message

In the PROFIBUS-DP communication model, a slave module consists of a certain number of inputs-outputs or inputs-outputs modules. Each module is defined by an identifier. This identifier contains information on the module direction (input, output or input-output), on the number of bytes or words and on the module consistency. The configuration is defined in the DP master and is sent to the slave by means of the Chk_Cfg function at the bus starting. The slave checks if this configuration is compatible and configures itself before switching on to data exchange mode (Data_Exchange).

There is also a communication mechanism more complicated than a basic inputs/outputs identifier: the PPO messages. These messages are often used in the "device profiles".

There are 5 PPO types defined for the various device profiles under Profibus:

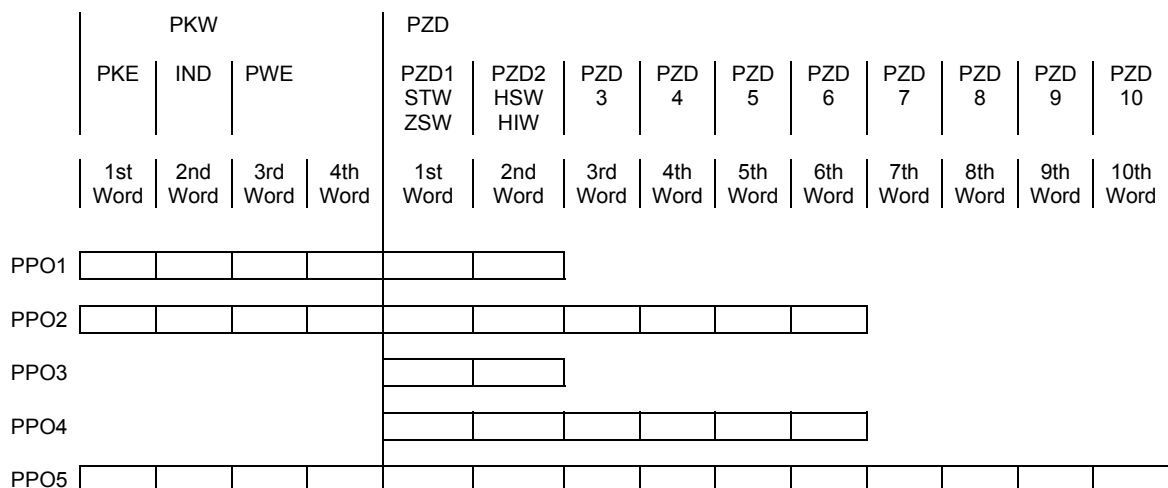

- PKW** Parameter setting data.
PKE Parameter code (bytes 1 to 2).
IND Index (byte 3).
PWE Parameter value (bytes 5 to 8).
PZD Process data (cyclically transferred).
STW Control.
ZSW Status.
HSW Input command.
HIW Information feedback.

A PPO message can contain 1 or 2 modules called PKW and PZD.

Each module (PKW or PZD) is defined as input-output and is consistent over the whole module length. The communication is made by the reading or writing of PPO messages (the PKW and PZD modules are input and output at the same time). The master sends a message by a PPO-write and receives a message by PPO-read. The PPO-write and PPO-read messages are cyclically transferred by the PROFIBUS DP Data_Exchange function.

The modules are consistent. This means that the different words of a same message must be transmitted or received in one single transfer. So, it is not possible to directly read or write in the PLC inputs/outputs area; special functions must be used for the data reading or writing.

Example: In the STEP7® software, the SFC14 and SFC15 functions are used for the reading and writing of the consistent modules.

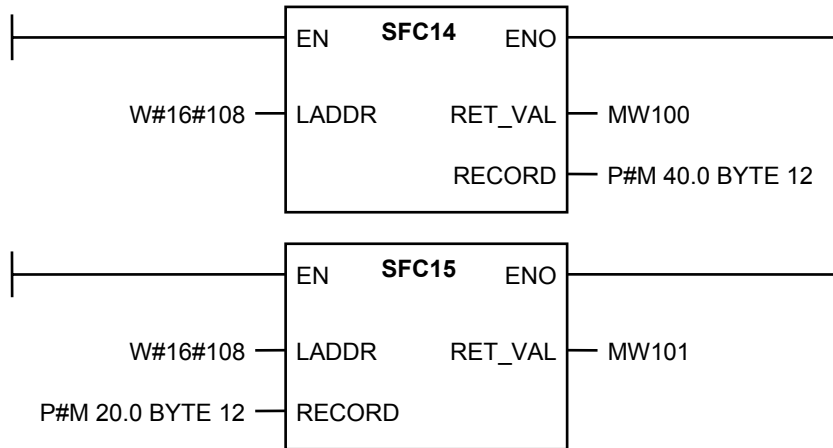

In the above example, the SFC14 and SFC15 functions are used for reading or writing the PZD module (PPO2 case). The W#16#108 address is the physical module address on the network that is obtained when connecting the slave to the network. This address is the same for the reading (SFC14) and writing (SFC15) because the module is an input-output module. The result of the reading will be transferred in the memory area at the address 40 by SFC14 (12 bytes). The SFC15 function will transfer the data at the address 20 (12 bytes) on the bus.

The PKW will require a SFC14 (reading) and a SFC15 (writing) and the PZD will require a SFC14 and a SFC15.

PKW is by definition used for the positioner parameter setting and PZD is used for its operational control.

The INFRANOR® positioner uses the PPO messages mechanism for communicating by Profibus-DP.

The SMT-BD1/p and CD1-p positioners accept the PPO1, PPO2, PPO3 or PPO4 types.

8.2 - Configuration

Normally, the identifiers of the various PPO types are automatically provided by the GSD file. Otherwise, they can be manually defined with values indicated in the table below:

PPO type	PKW	PZD
Type 1 ReadPPO1, WritePPO1 Configuration	PKW (4 words) Inputs/outputs module 4 words Consistency 0xF3	PZD Inputs/outputs module 2 words Consistency 0xF1
Type 2 ReadPPO2, WritePPO2 Configuration	PKW (4 words) Inputs/outputs module 4 words Consistency 0xF3	PZD Inputs/outputs module 6 words Consistency 0xF5
Type 3 ReadPPO3, WritePPO3 Configuration		PZD Inputs/outputs module 2 words Consistency 0xF1
Type 4 ReadPPO4, Write PPO4 Configuration		PZD Inputs/outputs module 6 words Consistency 0xF5

Example

When PPO2 is used, the identifiers are 0xF3 and 0xF5 (4 words for PKW and 6 words for PZD).

8.3 - Parameter setting (PKW)

The parameter area (PKW) allows to read or modify a parameter.

8.3.1 - Parameter identification (PKE)

The parameter code (PKE) is always on 16 bits:

Parameter identifier (PKE)					
Bit :	15	12	11	10	0
	AK		SPM	PNU	

Bits 0 to 10 (PNU) contain the parameter number (1 to 1999)

Bit 11 (SPM) indicates an event message: the parameter is modified and sent by the positioner

Bits 12 to 15 (AK) contain the instruction or reply code.

Instruction/Reply detail (AK)

Instruction code (master --> slave):

Instruction Code	Function	Positive reply code	Negative reply code
0	No instruction	0	
1	Read a parameter	1	7 / 8
2	Modify a parameter (word)	1	7 / 8
3	Modify a parameter (double word)	2	7 / 8

The reply code mentioned in the table above contains the normal replies associated with the instructions

Reply codes (slave -> master):

Reply code	Function
0	No function.
1	Value of the transferred parameter (word).
2	Value of the transferred parameter (double word).
7	Instruction cannot be executed (see error code in section 8.3.2).
8	PKW interface inhibited.

8.3.2 - Value of the PWE parameter

Master --> Slave

PWE includes the data for the parameter to be transferred:

- word: bytes 7 (MSB) and 8 (LSB).
- double word: bytes 5 (MSB) to 8 (LSB).

Slave --> Master

There are three possible cases regarding the slave's answer:

1st case: If the Master requests concerns a reading/writing on a variable (parameter) and when this action is correctly running, the slave answers with the variable value in the PWE area.

2nd case: If the instruction requested by the master cannot be executed, the slave answers with the value 7 in the AK area and gives the error code in the PWE area:

Error code	Description
0	PNU illegal
1	Parameter cannot be modified
2	Lower or upper limit exceeded
3	Index error
5	Incorrect data type
17	Instruction cannot be executed during the operation
18	Other error

3rd case: If the instruction requested by the master concerns a procedure (auto-tuning, auto-phasing, reading or writing in the EEPROM,...), the slaves answers with 0 in the PWE as long as the procedure is running. If the procedure has been successfully performed, the value of PWE switches to 1. If the procedure has ended with an error, PWE takes the value 2.

Note: During a procedure, the command must be maintained on the bus (and not re-started), as long as the PWE value is at 0.

IMPORTANT

Entering twice (one after the other) a same command corresponding to a procedure requires to insert a zero instruction (PKE = 0) between both instructions.

8.3.3 - Rule of the instruction/reply communication

- The master sends an instruction to the slave with the message "PPO write". It repeats this instruction until it gets a reply from the slave by "PPO read". This procedure guarantees the operator the instruction/reply communication.
- Just one single instruction can be executed at once.
- A slave provides the reply until the master sends a new instruction.
- An instruction (8 bytes) must be completely transferred in a message, and a reply as well.
- If no parameter setting information is required, the master must send 0 in AK (no instruction).

8.4 - Global control

The PROFIBUS DP global control mechanism allows the synchronizing of the outputs and inputs of several modules and several slaves. There are 4 global controls: SYNC, UNSYNC, FREEZE and UNFREEZE.

When the master sends a global SYNC control, the outputs of the addressed slave are frozen at their present values. When the master sends the next data, those are stored in the slave and the outputs status remains unchanged. When the next SYNC control is sent, the stored outputs values are switched through to the outputs. An UNSYNC control can be used for ending the synchronous mode.

The FREEZE control also allows the slave to freeze the inputs at their present values and to send them with the next data transfers. The inputs are not updated until the next FREEZE control. The FREEZE mode output can be left by means of an UNFREEZE control.

The SMT-BD1/p and CD1-p positioners accept the global controls SYNC, UNSYNC, FREEZE and UNFREEZE.

Chapter 3 - Programming

1 – GENERAL DESCRIPTION

Both SMT-BD1/p and CD1-p positioners can have up to 128 pre-programmed sequences. Each sequence can be either:

- an absolute motion or
- a relative motion or
- a homing or
- a speed profile or
- a torque sequence (speed profile with current limitation).

The sequences can also be linked up: when a sequence is over, it can switch on to another sequence.

The SMT-BD1/p and CD1-p positioners have got 8 virtual programmable logic outputs (triggering at the sequences execution) and 8 virtual logic inputs allowing to control a sequence start or stopping (the virtual logic inputs and outputs are only visible on the bus and have no physical existence).

The programming consists in initializing the sequences with the desired values.

2 – EDITION OF A SEQUENCE

Parameters of a sequence:

Move	Defines the motion type. ABS: absolute positioning. REL: relative positioning. HOME: axis homing. SPEED: speed profile. TORQUE: torque profile.
Position	Position to be reached in absolute or relative mode according to above parameter. If the motion type is a homing procedure, Position then indicates the value to be loaded in the position counter at the home position found.
Speed	Defines the motion speed in rpm.
Acceleration	Defines the acceleration ramp in ms.
Deceleration	Defines the deceleration ramp in ms. This parameter can be equal to 0 if a sequences linkage can be made without stopping the motor. See also chapter 5, section 2.8 "Manual motion parameters" for the definition of the parameters "motion speed", "acceleration time" and "deceleration time".
Delay Time or TimeOut	Defines, in ms, the delay time at the end of the positioning. If the motion is a homing procedure, this parameter defines, in seconds, the "time out", that is the time after which the positioner releases an error (if it does not find the home position). When this value is 0, the "time out" protection is not activated.
Next sequence	Defines the sequence to be executed after the current one.
Counter	Defines how many times the sequence must be executed. This counter is decremented each time a sequence is over.
Counter link or conditional jump	Defines the number of the sequence to be executed when the counter (see above) is not at 0.
Logic outputs	Defines the possible effect on the outputs.
Triggering	Defines the outputs triggering moment.
Triggering position	Defines the outputs triggering position.

Start condition The inputs which are not defined as sequence selection inputs can be programmed here for defining a start condition for the programmed sequence.

Example: As inputs 1 to 5 are defined for the sequence selection, inputs 6 to 8 can be used for the start condition.

Conditions: inputs 6 to 1
 Inputs 8 to 0
 input 7 not used

The Start Condition is the following: "0.1....." (input 7 and inputs 1 to 5 are not concerned by the Start Condition).

Consequently, this sequence can only be executed if input 6 is at 1 and input 8 at 0.

2.1 – Motion sequence

A motion sequence is defined by:

- the position to be reached (absolute or relative),
- the motion speed,
- the acceleration ramp,
- the deceleration ramp,
- a delay time at the end of the motion.

Linkage example of 2 motion sequences without stopping (the deceleration ramp of the first sequence is 0):

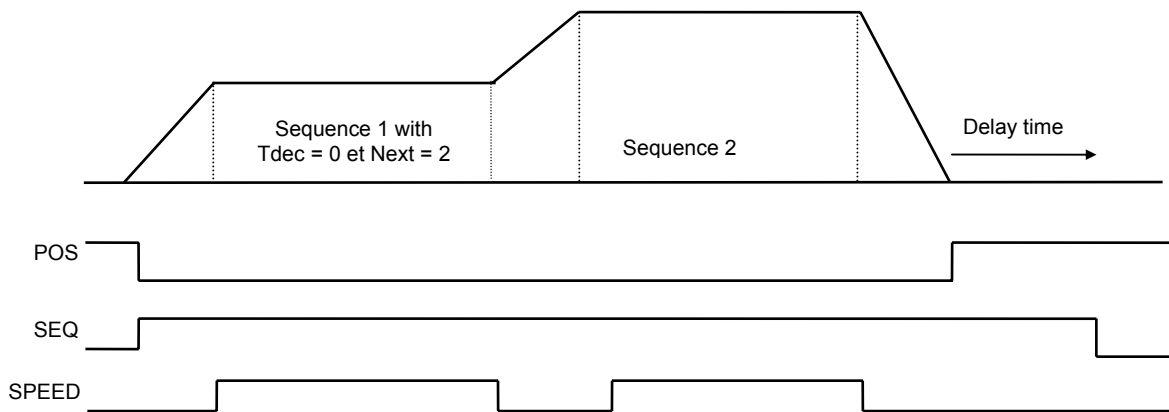

2.2 – Homing sequence

A homing sequence is defined by:

- the motion speed,
- the acceleration ramp,
- the deceleration ramp,
- a time out,
- a position reset value,
- the control (5 bits):

Dir Searching direction: 0 for the positive direction and 1 for the negative direction.

Switch Homing with switch detection.

Zero Homing with marker pulse detection.

Origin In a case with switch, this parameter allows to come back to the home position (motion reversal); otherwise the motor will be stopped after the braking.

Reset Load the position reset value in the position counter at the home position.

Homing procedure diagram:

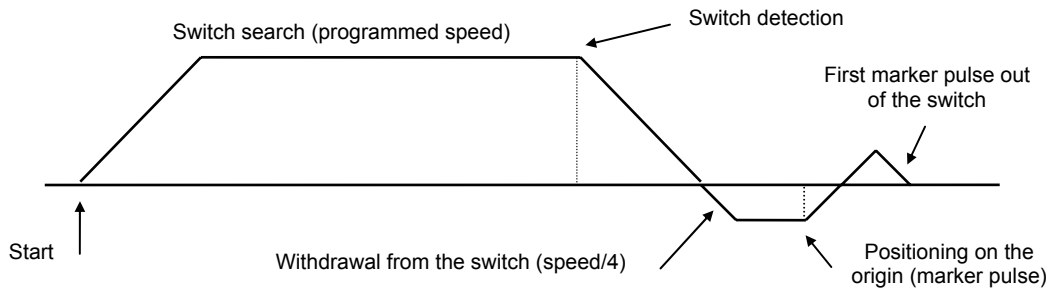

Note: When the motor enters the switch (rising edge), the amplifier stores the position. If the output (falling edge) is not detected, it uses the entering position for calculating the index position.

If **Switch** = 1 and **Zero** = 1 or **Origin** = 1, the speed can be reversed by the switch detection or by a limit switch.

Procedure diagram with switch:

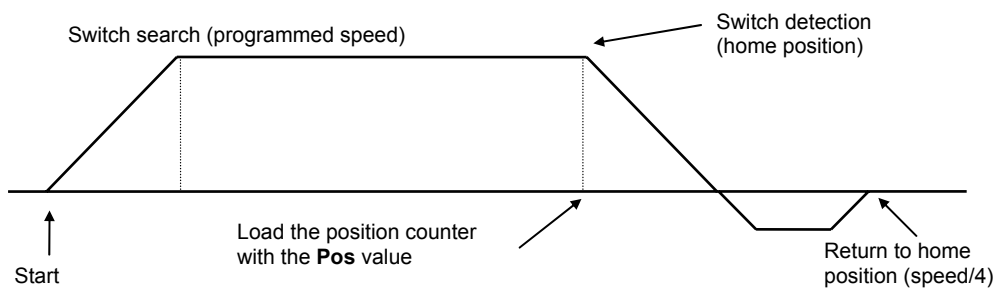

When sequence 0 contains a homing procedure, no other sequence can be executed, at power on, before sequence 0.

2.3 – Speed sequence

A speed sequence is defined by:

- The motion speed
- The motion time
- The acceleration time
- The deceleration time.

When the motion time exceeds 16000 ms, the stop condition can be used for stopping the sequence.

Note: If the "Stop" box is ticked off, the sequence start condition becomes a stop condition.

The sequences linkage allows to create speed profiles.

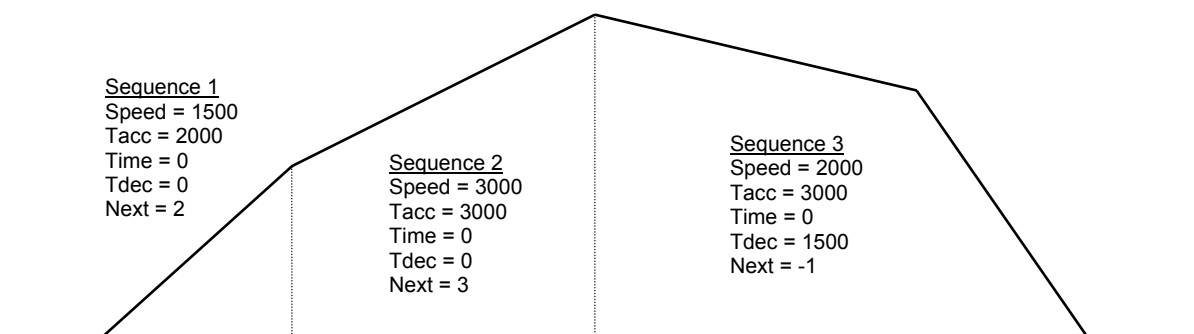

The "acceleration" and "deceleration" parameters are real acceleration and deceleration times and not acceleration and deceleration ramps as they are in a positioning sequence or a homing sequence.

Note: Next sequence = -1 corresponds to an empty box in the sequence edition of the PC software.

2.4 – Torque sequence (on CD1p, and from EPROM version 507.18 on BD1p)

A torque sequence is defined by:

- the motion speed
- the acceleration time
- the deceleration time
- the torque input command
- the torque application time.

The "Acceleration" and "Deceleration" parameters are acceleration and deceleration times.

In a torque sequence, the motor runs at constant speed until it is locked. The current then raises up to the value defined in percentage of the max. current value defined by the **Max. current** parameter. When the motor has got a zero speed and the current is reached, the positioner is holding at this current during the time defined by the **Delay time** parameter.

If the **Delay time** exceeds 16000, the torque holding is infinite. The torque sequence can be left either by:

- the START signal that starts another sequence or by
- the signals of a stop condition (if the Stop box is ticked off).

The triggering of the « HOLD » outputs allows the outputs activation when the motor speed is zero and the current is reached.

Execution of a torque sequence

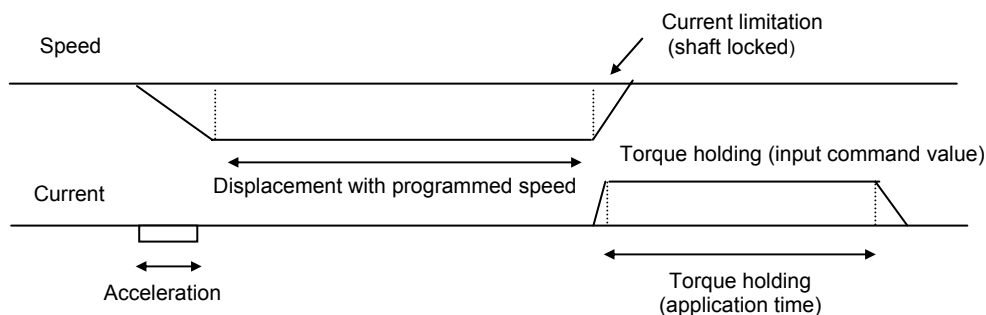

2.5 - Sequence control

2.5.1 - Counting loop

The sequences linkage is controlled by the parameters "Next sequence", "Counter" and "Jump".

Example:	Sequence 1:	Next sequence = 2 Counter = 0 Jump = -1
	Sequence 2:	Next sequence = 3 Counter = 2 Jump = 1
	Sequence 3:	Next sequence = -1 Counter = 0 Jump = -1

Note: "Next sequence" = -1 or "Jump" = -1 correspond to an empty field in the sequence editor.

If the execution starts at sequence 1, the programme will be the following:

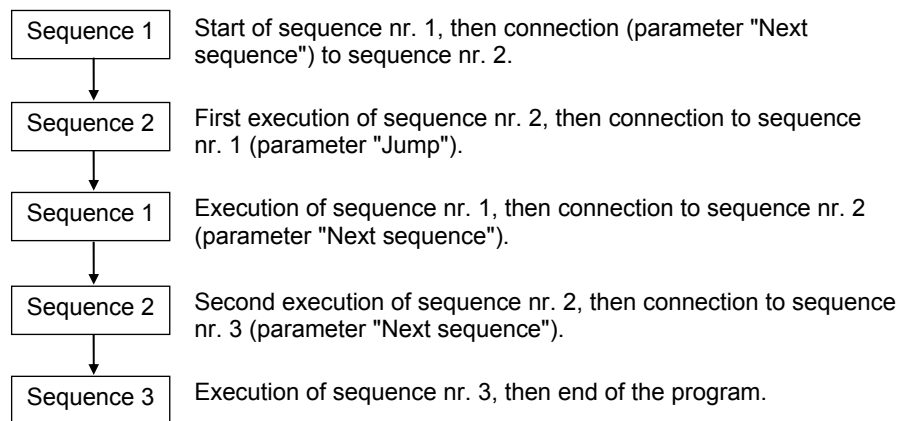

2.5.2 - Conditional jump

The conditional jump is controlled by the parameters **Start condition**, **Next sequence**, **Counter** and **Jump**.

Application example:

- Sequence 1: Next sequence = 2
Counter = 0
Jump = -1
- Sequence 2: Next sequence = 3
Counter = 0
Jump = 4
Start condition = Logic input 8 activated
- Sequence 3: Next sequence = -1
Counter = 0
Jump = -1
- Sequence 4: Next sequence = -1
Counter = 0
Jump = -1

Note: "Next sequence" = -1 or "Jump" = -1 correspond to an empty field of the parameter in the parameter setting software.

If the execution starts with sequence 1, and if logic output 8 is active, the program will be the following:

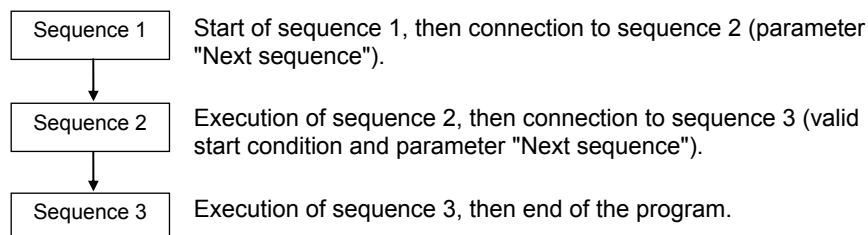

If the execution is starting with sequence 1 and if input 8 is disabled, the program will be the following:

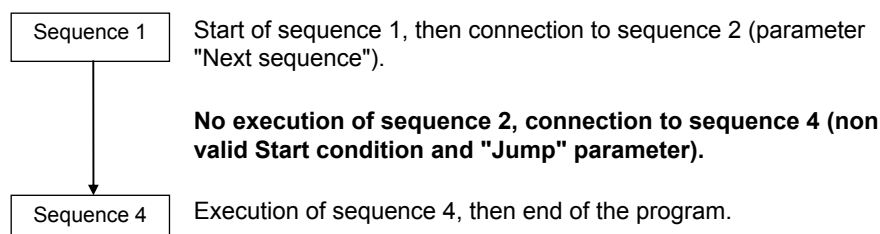

2.6 - Logic outputs (virtual)

The action on the 8 logic outputs can be defined as described below:

- do not modify the output status,
- set the output at 1,
- set the output at 0,
- reverse the output (toggle).

The outputs triggering moment ("Triggering" parameter) can be defined during a motion, according to the 5 different ways described below:

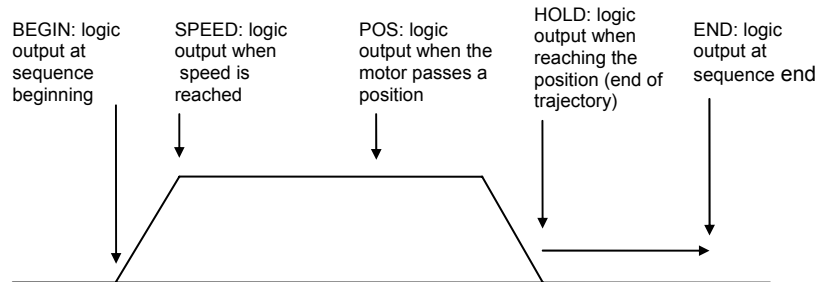

In a homing sequence, the outputs trigger only at the end of the sequence.

In a speed sequence, the "HOLD" and "POS" triggering is not possible.

Triggering position: Defines the position where the logic output must be triggered when it is programmed in "POS" triggering (see above).

Chapter 4 - Operation

1 - COMMUNICATION

The positioner is driven by Profibus with the PZD data area.

Master -> slave (PLC -> positioner):
 - Control (STW)
 - Input command (HSW)

Slave -> master (positioner -> PLC):
 - Status (ZSW)
 - Feedback (HIW)

1.1 – Control word

Bit	Value	Meaning	Notes
0	1	ON	Enabling.
	0	OFF1	Stop, braking and disabling.
1	1	Operational condition	Positioner ready.
	0	OFF2	
2	1	Operational condition	Emergency stop: maximum deceleration.
	0	OFF3	
3	1	Operation enabled	
4	1	Operational condition for the positioner	A sequence can be executed on an edge of bit 6.
	0	Stop	Maximum braking.
5	1	Operational condition for the positioner	Must be set at 1 for a sequence execution.
	0	Intermediate stop	Braking with programmed deceleration.
6	↑↓	Execute positioner function	Each edge on this bit releases the execution of the selected sequence.
7	↑	Fault acknowledgment	Positioner fault reset.
8	1	Jog +	Continuous motor movement in the positive counting direction.
	0		
9	1	Jog -	Continuous motor movement in the negative counting direction.
	0		
10	1	Command	Control by profibus
	0	Local	Local mode control by RS-232
11	↑	Homing	Release a homing procedure on the rising edge of this bit.
12	↑↓	Absolute positioning	
13	↑↓	Relative positioning	
14			
15			

During a positioning by bit 12 or bit 13, the 32 bit position input command is contained in words 5 and 6 of the PZD.

1.2 – Input command

The input command is contained in HSW (2nd word of PZD - PPO write).
 It has different meanings according to the positioning or speed control.

In positioning mode:

Bits 0 to 7: number of the sequence to be executed.

Bits 8 to 15: logic inputs (bits 0 to 7). These inputs are used for the sequence start (or stop) conditions.

In speed mode:

Speed input command on 16 bits: 0x7FFF corresponds to maximum speed.

1.3 - Status

Bit	Value	Meaning	Notes
0	1 0	Ready for enabling Not ready	Ready for enabling (ENABLE).
1	1 0	Ready for operation	
2	1 0	Operation enabled	
3	1 0	Error	Positioner fault after error reset; is in "disabled" status.
4	1 0	No OFF2 OFF2	Instruction "OFF2" available
5	1 0	No OFF3 OFF3	Instruction "OFF3" available
6	1 0	Enabling inhibited Enabling	
7	1 0	Warning	Warning signal; the positioner goes on operating.
8	1 0	No following error Following error	
9	1 0	Operation via Profibus Operation in local mode	
10	1 0	Position is reached	
11	1 0	Home position found	
12	↑↓	Input command acknowledgment	Acknowledgment of a sequence triggering
13	1 0	Motor stopped	
14	1 0	Sequence running	
15	1 0	Speed is reached	

Notes

- When the motor reaches a limit switch, the following error is activated (bit 8) and the positioner fault is not activated (bit 3). The motor remains enabled.
- When switching from the "Profibus" mode to local mode or vice versa, the positioner is disabled.

1.4 - Feedback

The feedback is included in HIW (2nd word of PZD - PPO read).
It has got different meanings according to positioning or speed control.

In positioning mode:

Bits 0 to 7 of the HIW: number of the running sequence (otherwise 0xFF).
Bits 8 to 15 of the HIW: programmable logic outputs (0 to 7).

If PPO2 or PPO4 are used:

PZD3 contains the current monitor in the motor.
PZD4 contains the motor speed.
PZD5 (MSB) and PZD6 (LSB) contain the motor position.

In speed mode:

Motor speed (0x7FFF corresponds to the maximum motor speed).

2 - Operation diagram

2.1 - Positioner control process

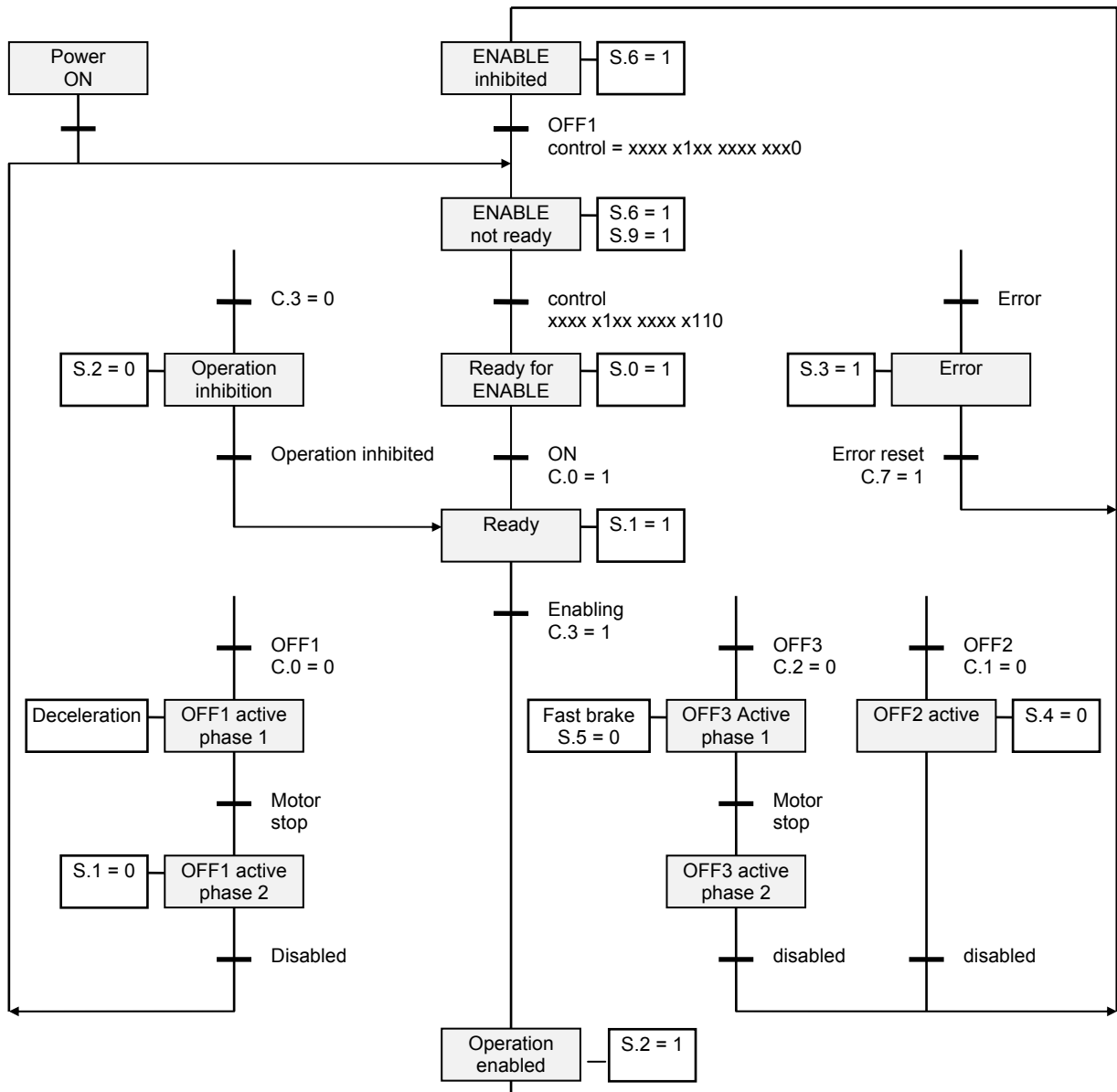

Notes:

- ENABLE Enabling.
- C.n Indicates bit n of the control word (see section 1.1).
- S.n Indicates bit n of the status word (see section 1.3).

This diagram describes the positioner behaviour:

The enabling process includes 5 stages: "ENABLE inhibited", "ENABLE not ready", "Ready for ENABLE", "Ready" and "Operation enabled".

The 3 OFF1, OFF2 and OFF3 functions correspond to the various ways to disable the motor.

The functions "Error" and "OFF" are effective at each level of the diagram. "OFF3" is a stop with maximum deceleration. "OFF2" has a priority over "OFF1" which has a priority over "OFF3".

Contrarily to the parameter setting, there is no direct acknowledgment for each control word bit. The positioner status must be checked in order to make sure that the command could be executed.

2.2 – Positioning mode

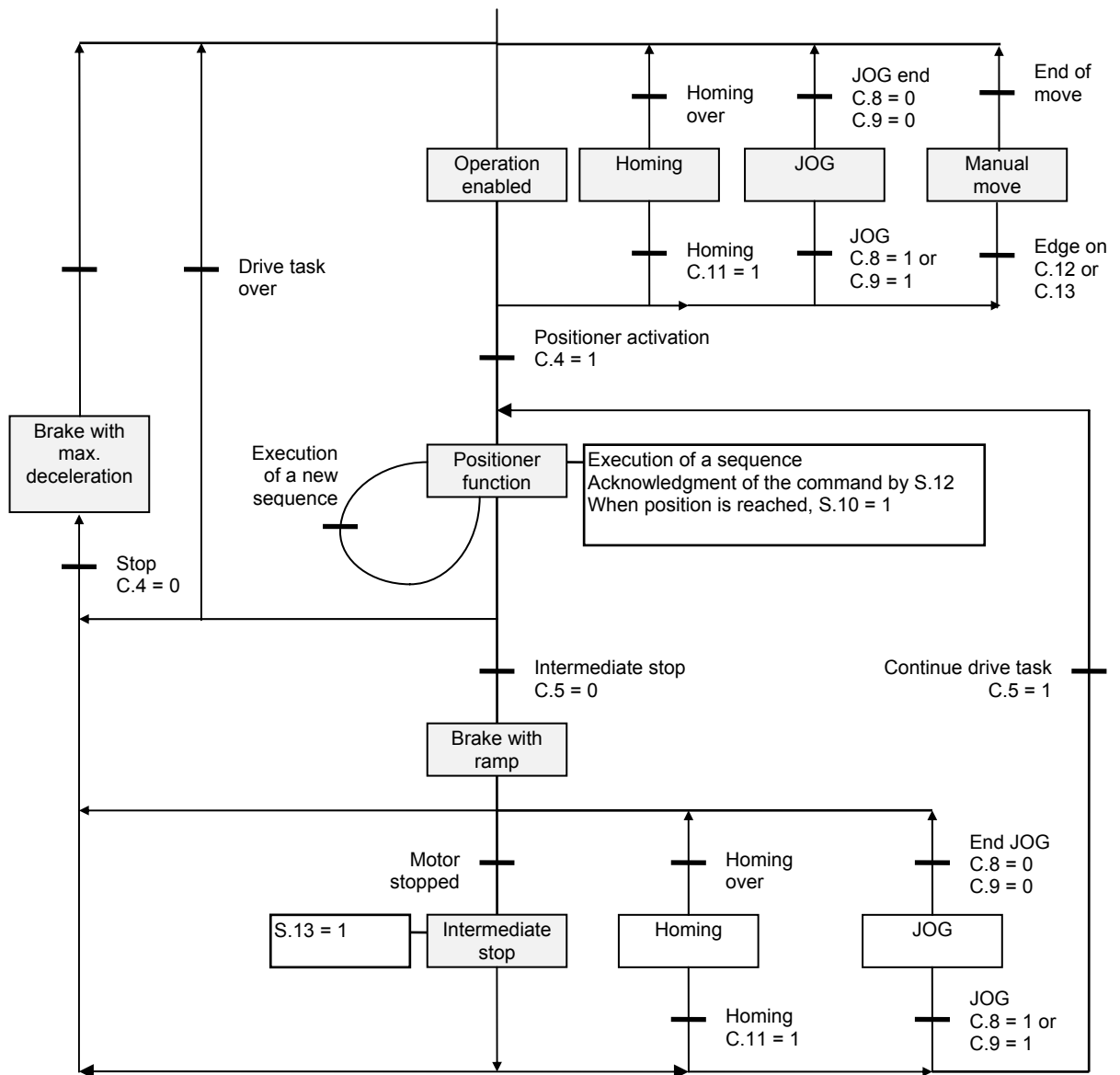

When the positioner is in "Operation enabled" status, the following actions are possible:

- starting a sequence execution (bit 6),
- jog+ or jog- (bit 8 or 9),
- homing (bit 11),
- absolute positioning (bit 12),
- relative positioning (bit 13),
- stopping the motor with a programmed deceleration – the one defined by JOG (bit 5) -,
- stopping the motor with maximum deceleration (bit 4).

3 – DRIVING OF THE POSITIONER

3.1 – Enabling/disabling

The enabling procedure is defined in the diagram of section 2.1

Example of a simplified enabling:

Stages	Communication	Value
1	PLC -> Positioner	Send control word = 0400h
2	PLC -> Positioner	Send control word = 0406h
3	PLC -> Positioner	Send control word = 0407h
4	PLC -> Positioner	Send control word = 043Fh
5	Positioner -> PLC	Check status word = xxxx xx11 xx11 0111b

Notes

- The positioner bus cycle time is 1 ms; check for at least 1 ms between 2 commands.
- In the above procedure, the positioner status is not checked at each stage but only at the end.

The disabling can be simply made by disabling one of the OFF1 or OFF2 or OFF3 bits.

3.2 – Starting a sequence

When the positioner is in "Operation enabled" status, a sequence is started by:

- entering the sequence number in PZD 2,
- reversing bit 6 of the control word.

If a new sequence is started whereas the positioner is executing a sequence, the positioner immediately executes the new sequence without stopping the motor.

3.3 – Other movements

The other possible non programmed movements are:

- jog+ or Jog- (bit 8 or 9),
- homing (bit 11),
- absolute positioning (bit 12),
- relative positioning (bit 13).

The movements are mutually exclusive (including a sequence execution): when a movement is running, no other movement is possible.

For absolute or relative positionings, the 32 bit position input command is contained in PZD5 and PZD6.

3.4 – Speed control

It is also possible to control the positioner in speed mode:

- switch to speed mode by means of parameter PNU 720, with disabled motor. At power on, the amplifier is always in positioning mode.
- the PLC must send the speed input command in PZD2 (16 bits full scale) of the PPO-write.
- the PLC can read the motor speed monitor in PZD2 (16 bits full scale) of the PPO-read.

Chapter 5 - Parameter setting by Profibus

1 – PARAMETER LIST

PNU	Parameter	Unit	Min.	Max.	Size	R/W	Saving	Fault value
700	Number of motor pole pairs		1	12	word	R/W	E	4
701	Motor phases order				word	R/W	E	0xAAAA
702	Resolver shift		0	65535	word	R/W	E	0
703	Phase lead				word	R/W	E	0
704	Auto-phasing procedure					W		
710	Max. current	%	6553	32767	word	R/W	E	0x7FFF
711	Rated current	%	6553	16384	word	R/W	E	0x4000
712	I ² t protection mode				Boolean	R/W	E	1
713	Current limitation	%	0	32767	word	R/W		0x7FFF
714	Speed modulation	%	0	32767	word	R/W		
715+	Current / Voltage rating				word	R		
716+	Kp gain of D current loop		1	65535	word	R/W	E	0x100
717+	Ki gain of D current loop		0	65535	word	R/W	E	0
718+	Kp gain of Q current loop		1	65535	word	R/W	E	0x100
719+	Ki gain of Q current loop		0	65535	word	R/W	E	0
720	Positioner mode				word	R/W		
721	Max. motor speed	rpm	100	10000	word	R/W	E	3000
722	Motor rotation direction				Boolean	R/W	E	0
723	Acceleration ramp	ms	0	16000	word	R/W	E	1
725+	Motor thermal sensor configuration				Boolean	R/W	E	
726	Brake control active delay	ms	0	16000	word	R/W	E	0
727	Brake control inactive delay	ms	0	16000	word	R/W	E	0
728	Manual brake control				Boolean	W		
729	Saving in an EEPROM				-	W		
730	Proportional speed loop gain		0	65535	word	R/W	E	0x64
731	Integral speed loop gain		0	65535	word	R/W	E	0
732	Proportional position loop gain		0	65535	word	R/W	E	0
733	Feedforward Speed 1 Gain		0	65535	word	R/W	E	0
734	Current control filter		2832	61545	word	R/W	E	0x3000
735	Anti-resonance filter		0	1	Boolean	R/W	E	0
736	Auto-tuning procedure		0	5	word	W		
737+	Feedforward Acceleration gain		0	65535	word	R/W	E	0
738+	Feedforward Speed 2 Gain		0	65535	word	R/W	E	0
739+	Damping Speed Gain		0	65535	word	R/W	E	0
740	Position resolution	ppr	16	65534	word	R/W	E	0x1388
741	Following error threshold	pulse	1	32767	word	R/W	E	0x7FFF
742	Positioner configuration				word	R/W	E	0
743	User Output				word	R/W		0
744*	Dead band				word	R/W	E	0
745*	Position modulo				double	R/W	E	0
746*	Counter position reset (CLEAR input)				double	R/W	E	0
747*	Negative software limit switch				double	R/W	E	0x7FFFFFFF
748*	Positive software limit switch				double	R/W	E	0x80000000
750	Encoder output resolution		16	8192	word	R/W	E	0x400
751	Number of marker pulses		1	16	word	R/W	E	1
752	Marker pulse shift		0	32767	word	R/W	E	0
753	Marker pulse width		0	32767	word	R/W	E	0x10
754	Encoder output programming				-	W		
756*	Minimum duration SEQ output	ms	0	16383	word	R/W	E	0

757*	"INPOS" window				double	R/W	E	0
758*	CAM Position 1				double	R/W	E	
759*	CAM Position 2				double	R/W	E	
760	Manual move speed	rpm	1	10000	word	R/W	E	0x64
761	Manual mode acceleration	ms	1	16000	word	R/W	E	0x320
762	Manual mode deceleration	ms	1	16000	word	R/W	E	0x320
763	Speed in jog	rpm	1	10000	word	R/W	E	0x1F4
764	Acceleration in jog	ms	1	16000	word	R/W	E	0x320
765	Deceleration in jog	ms	1	16000	word	R/W	E	0x320
766	Homing configuration				16 bits	R/W		0x0F0
767	Position input command	pulse	A	B	double	R/W		0
768	Offset Homing	pulse	A	B	double	R/W		0
769*	Reading of the logic inputs				16 bits	R		
770	Positioner software version	-			double	R		
771	Profibus software version	-			word	R		
773	Positioner error	-			double	R		
774	Motor position	pulse			double	R		
775	Resolver value	pulse	0	65535	word	R		
776	Motor speed		-32767	+32767	integer	R		
777	Motor current		-32767	+32767	Integer	R		
778+	Fault code				word	R		
780	Sequence reading				word	W		
781	Sequence writing				word	W		
782	Sequence control				16 bits	R/W	S	
783	Position in the sequence	pulse	A	B	double	R/W	S	
784	Speed in the sequence	rpm	0	10000	word	R/W	S	
785	Acceleration in the sequence	ms	1	16000	word	R/W	S	
786	Deceleration in the sequence	ms	0	16000	word	R/W	S	
787	Delay / running time	ms	0	16767	word	R/W	S	
788	Link (next sequence)		-1	127	word	R/W	S	
789	Counter		0	32767	word	R/W	S	
790	Counter link / conditional jump		-1	127	word	R/W	S	
791	Start condition				16 bits	R/W	S	
792	Programmable logic outputs				16 bits	R/W	S	
793	Triggering position	pulse	A	B	double	R/W	S	
794	Torque setpoint	%	0	32767	word	R/W	S	
795	Sequence control modification				16 bits	R/W		
796	Position modification	pulse	A	B	double	R/W		
797	Speed modification	rpm	0	10000	word	R/W		
798+	Modification of a sequence acceleration	ms	1	16000	word	R/W		
799+	Modification of a sequence deceleration	ms	1	16000	word	R/W		
800+	Modification of the delay/running time in a sequence	ms	1	16000	word	R/W		
801+	Modification of the link in a sequence (next sequence)		-1	127	word	R/W		
802+	Modification of the counter in a sequence		0	16000	word	R/W		
803+	Counter link/conditional jump modification		-1	127	word	R/W		
804+	Modification of the conditional inputs (Start condition)				16 bits	R/W		
805+	Modification of the conditional outputs				16 bits	R/W		
806+	Triggering position modification	pulse	A	B				
807	Torque setpoint modification	%	0	32767	word	R/W		

- Notes**
- * PNU not available for BD1/p version 506.78 and CD1-p version 508.18
 - + PNU available for CD1-p only
 - R/W Reading/Writing
 - A* Lower value limit in position = -32768 x (position resolution)
 - B* Upper value limit in position = +32768 x (position resolution) - 1
- These limit values are theoretic values of the positioner.

Saving:

- E These parameters are saved in the EEPROM by instruction 729.
 S These parameters are saved in the EEPROM by the instruction "Sequence writing" 781.

The words in brackets in the parameter description correspond to the field pertaining to this parameter in the parameter setting software.

CAUTION !

The EEPROM life time is about 10000 writing cycles. If you need to frequently write in the EEPROM, we recommend to use the NovRAM option (battery-saved RAM) instead of the standard EEPROM.

2 – PARAMETERS DESCRIPTION

2.1 - Motor parameters

Synchronous motor parameters PNU : **700, 701, 702**

Defines the parameters required for driving synchronous motors. These parameters can be calculated by the auto-phasing procedure.

<i>Parameter</i>	Number of motor pole pairs (1 to 12). Motor phase order: corresponds to the phase order (U, V, W) of the motor connection. Sensor adjustment: phase shift between resolver and motor rotor.
<i>Conversion</i>	Motor phase 2 possible values (0x5555 or 0xAAAA). Sensor adjustment 5.4931640625e-3*(number of pole pairs). The value obtained is the shift in electrical degrees.
<i>Execution</i>	With disabled positioner.

Phase lead coefficient PNU : **703**

<i>Parameter</i>	16 bits. (55-7446)
<i>Conversion</i>	4.57771654e-5 (electrical degree/1000 rpm)

Phase shift:

$$\tan\varphi = \frac{0,6 \cdot 10^{-7} \cdot K_t \cdot N_p \cdot (\text{Max.MotorSpeed})^2}{L \cdot I_{\text{rated}}}$$

K_t: motor torque constant (Nm/A_{rms})
 N_p: number of motor pole pairs
 Max.MotorSpeed: maximum motor speed (rpm)
 I_{rated}: motor current (A_{rms})

with: $0 \leq \varphi \leq 45^\circ$

Phase lead coefficient (electrical degree/1000 rpm):

$$\text{Coef} = \varphi \frac{1000}{\text{Max.MotorSpeed}}$$

Auto-phasing PNU : **704**

<i>Parameter</i>	None.
<i>Limitation</i>	Writing only.
<i>Note</i>	This procedure allows the automatic calculation of the motor parameters: <ul style="list-style-type: none"> - number of motor pole pairs, - motor phase order, - resolver offset.



The motor must first be disabled and **uncoupled from the mechanical load**. The ENABLE signal (X4 connector) must also be active. Before executing the procedure, check for free motor shaft rotation over one revolution, that is not dangerous for the operator. When the motor parameters are known, it is not necessary to execute the auto-phasing.

2.2 – Current parameters

Maximum current PNU : 710

Defines the max. current limitation in the motor.

Parameter 1 word.

Conversion in percentage of the positioner current rating: x 3.051850948e-3.

Limitation 6554 (20%) to 32767 (100%)

Execution

Note This parameter is defined according to the positioner and motor specifications.

Rated current PNU : 711

Defines the rated current limitation in the motor.

Parameter 1 word.

Conversion in percentage of the current rating: x 3.051850948e-3.

Limitation 6554 (20 %) to 16384 (50%)

Execution

Note This parameter is defined according to the positioner and motor specifications.

I²t mode PNU : 712

Parameter 1 word.

0 limiting mode.

1 fusing mode.

Note See [manual of the SMT-BD1 standard positioner for the I²t protection mode](#).

Current limitation PNU : 713

Defines the current limitation in the motor with regard to the value defined by the maximum current.

Parameter 1 word.

Limitation 0 to 32767 (100% of I_{max})

Speed modulation PNU : 714

This parameter allows a speed modulation. The value corresponds to a percentage of the programmed speed. In homing sequences, this parameter corresponds to a speed limitation. The percentage of the programmed speed will actually be applied when starting the sequence and any modification of this percentage will have no effect until the motion is over.

Parameter 1 word.

Unit %

Limitation 0 to 32767 (100%)

Current/Voltage rating identification PNU : 715

Gives the positioner current rating and voltage.

Parameter bit 4 : 0 230 V positioner
1 400 V positioner

Bits 3, 2, 1, 0	Rating (Arms) in 230 V	Rating (Arms) in 400 V
1	2.25	1.8
2	4.5	2.7
3	7.5	5.1
4	10.5	7.2
5	16.5	14
6	27	30
7		45
8	45	60
9	60	90
10	90	
11	120	

Limitation CD1-p only

The CD1-p positioner has 2 digital PI regulators for the D-Q current loops. The gains are the following:

Proportional gain for D current loop	PNU :	716
Integral gain for D current loop	PNU :	717
Proportional gain for Q current loop	PNU :	718
Integral gain for Q current loop	PNU :	719

2.3 – Application parameters

Positioner mode	PNU :	720
Defines the positioner operation mode (position, speed or torque).		
<i>Parameter</i>	1 word	
	1	torque mode
	2	speed mode with PI regulator
	4	positioner mode
	8	speed mode with P regulator
	16	speed mode with PI ² regulator
<i>Execution</i>	This instruction must be executed with disabled positioner. In standard, the positioner is always configured in position mode at power on.	
Max. speed	PNU :	721
Defines the maximum application speed (and the speed scale as well).		
<i>Parameter</i>	1 word.	
<i>Limitation</i>	This parameter varies between 100 rpm and 10000 rpm.	
<i>Execution</i>	With disabled positioner.	
Motor rotation direction	PNU :	722
This instruction allows to reverse the motor rotation direction with regard to the input command. It also reverses the position feedback.		
<i>Parameter</i>	1 word :	
	= 0:	normal.
	= 1:	reversed.
<i>Execution</i>	With disabled positioner.	
Acceleration ramp	PNU :	723
Defines the motor acceleration or deceleration time that corresponds to the maximum speed.		
<i>Parameter</i>	1 word.	
<i>Conversion</i>	in second: x 0.0005	
<i>Limitation</i>	1 (without acceleration ramp) at 65535 (#30 s).	
<i>Note</i>	This parameter can only be used in speed mode.	
Motor thermal sensor	PNU :	725
Defines the motor thermal sensor type used.		
<i>Parameter</i>	Boolean.	
	0	NTC sensor
	1	PTC sensor
Brake delay active	PNU :	726
Defines the time between the brake release and the positioner disabling.		
<i>Parameter</i>	1 word	
<i>Unit</i>	ms	
<i>Limitation</i>	0-16000	
Brake delay inactive	PNU :	727
Defines the time between the positioner enabling and the brake inhibition.		
<i>Parameter</i>	1 word	
<i>Unit</i>	ms	
<i>Limitation</i>	0-16000	

Manual brake control

PNU :

728

This instruction enables or inhibits the brake.

- Parameter 1 word.
- 0 inhibits the brake relay output (relay closed).
- 1 releases the brake relay output (relay open).
- Limitation Writing only.

Saving in the EEPROM

PNU :

729

Saves all positioner parameters in the EEPROM.

- Parameter none.
- Limitation Writing only.
- Execution With positioner disabled.
- Note All parameters modified by the other instructions (except for the sequence parameters) are not saved. This instruction must be used to store them definitively in the positioner.

2.4 – Regulator parameters

The structure of the regulator used for the SMT-BD1/p is shown below :

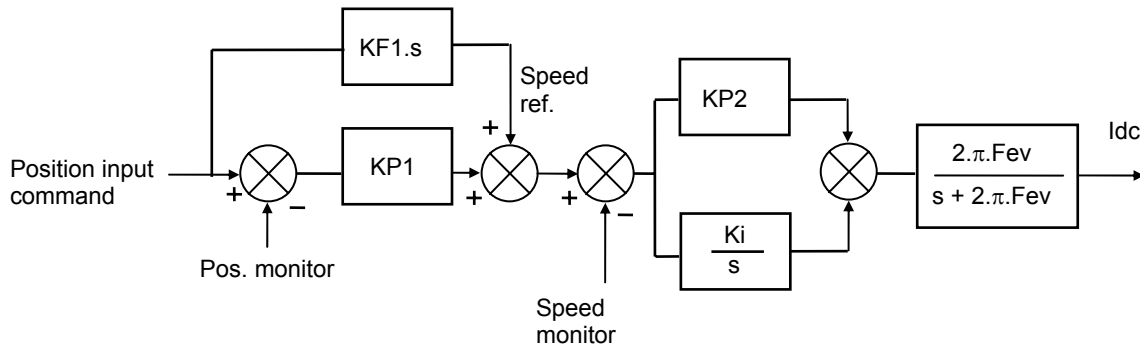

The structure of the regulator used for the CD1-p is shown below :

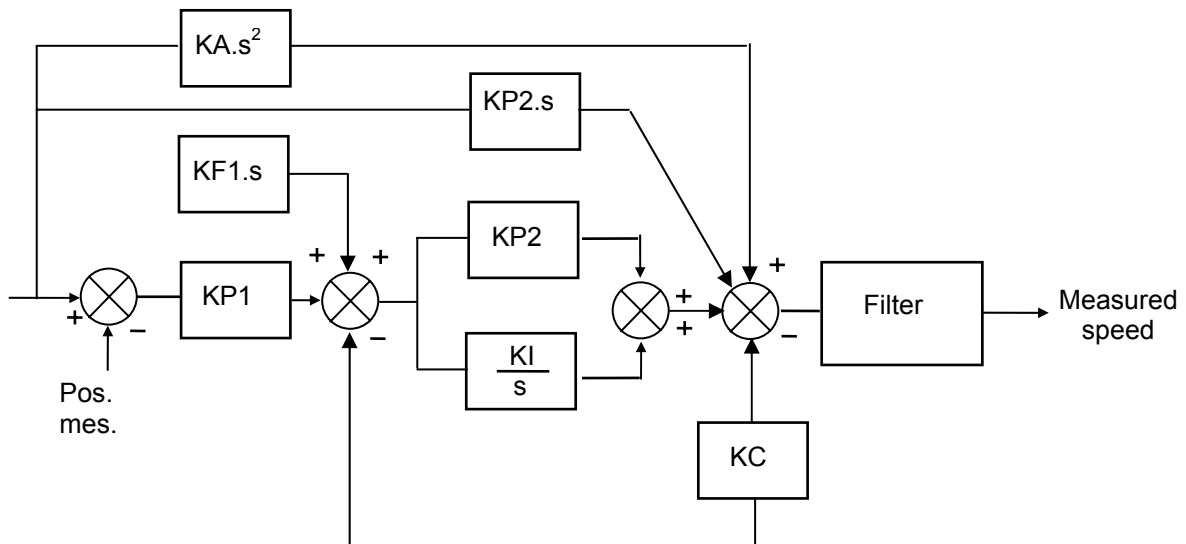

All gain parameters (KF1, KF2, KP1, KP2, KI, KA, KC and Fev) are automatically calculated during the auto-tuning procedure.

Proportional speed loop gain		PNU :	730
Defines the proportional regulator gain (KP2) that acts upon the speed error.			
<i>Parameter</i>	1 word.		
<i>Conversion</i>	1/16		
<i>Limitation</i>	0 to 65535		
Integral speed loop gain		PNU :	731
Defines the integral regulator gain (KI) that acts upon the speed error.			
<i>Parameter</i>	1 word.		
<i>Conversion</i>	1/256		
<i>Limitation</i>	0 to 65535		
Proportional position loop gain		PNU :	732
Defines the proportional gain that acts upon the position error (KP1).			
<i>Parameter</i>	1 word.		
<i>Conversion</i>	1/65536		
<i>Limitation</i>	0 to 65535		
Feedforward speed 1		PNU :	733
Defines the feedforward speed amplitude (KF) corresponding to the speed input command (derivation of the position input command). This feedforward term allows to reduce the following error during the motor acceleration and deceleration phases.			
<i>Parameter</i>	1 word.		
<i>Conversion</i>	1/65536		
<i>Limitation</i>	0 to 65535		
Current control low-pass filter		PNU :	734
Defines the cut-off frequency at -3 dB (Fev) of the first order filter that acts upon the current control. The value of this parameter is depending on the selected bandwidth.			
<i>Parameter</i>	1 word.		
<i>Conversion</i>	Frequency (Hz) = $1000/\pi * \ln(65536/\text{parameter})$		
<i>Limitation</i>	This parameter can take a value between 2832 (1000 Hz) and 61545 (20 Hz).		
Antiresonance filter		PNU :	735
Releases or inhibits the antiresonance filter.			
<i>Parameter</i>	1 word.		
	= 0: inhibits the filter,		
	= 1: releases the filter.		
Auto-tuning		PNU :	736
This procedure identifies the specific motor and load parameters and calculates the regulator gain parameters.			
<i>Parameter</i>	1 word.		
	0 low bandwidth.		
	1 medium bandwidth.		
	2 high bandwidth.		
	3 low bandwidth with antiresonance filter.		
	4 medium bandwidth with antiresonance filter.		
	5 high bandwidth with antiresonance filter.		
	6 low bandwidth with high stiffness filter.		
	7 medium bandwidth with high stiffness filter.		
	8 high bandwidth with high stiffness filter.		
<i>Limitation</i>	Writing only.		
<i>Execution</i>	With disabled positioner and ENABLE signal activated, or enabled positioner and motor at standstill (zero speed).		
<i>Note</i>	When executing this procedure, the speed loop bandwidth can be selected (low, medium or high). These values correspond to the cut-off frequency for a 45° speed loop phase shift. The reading indicates the previously selected bandwidth (0, 1, 2, 3, 4 or 5). Before executing this instruction, check for free motor shaft rotation over one revolution, that is not dangerous for the operator. The auto-tuning procedure is not required when the regulator parameters are known.		



Feedforward acceleration gain PNU : 737

Defines the feedforward acceleration corresponding to the acceleration input command (second derivation of the position input command). This feedforward term allows to reduce the following error during the motor acceleration and deceleration phases.

Parameter word.
Conversion 1
Limitation 0 to 65535

Feedforward Speed 2 gain PNU : 738

This gain value is equal to the damping speed gain value + Feedforward friction gain value. The feedforward friction gain allows to cancel the load viscous friction effect (load viscous friction torque is proportional to axis speed). This feedforward term allows to reduce the following error during the motor acceleration and deceleration phases.

Parameter word.
Conversion 1/16
Limitation 0 to 65535

Speed loop damping gain PNU : 739

This gain is used for getting the maximum servo loop stiffness.

Parameter word.
Conversion 1/16
Limitation 0 to 65535

2.5 – Positioner parameters

Position resolution PNU : 740

Defines the position resolution (ppr)

Parameter 1 word.
Limitation 0, corresponding to a resolution of 65536 (full scale), or from 512 to 65534 (always an even number).
Execution With disabled positioner.
Note This position resolution consequently defines the format of both position input command and position feedback.

Position error threshold PNU : 741

Defines the position error triggering threshold.

Parameter 1 word.
Conversion See position resolution.

Positioner configuration PNU : 742

<i>Parameter</i>	bit	description
	0*	Positive limit switch (software FC+)
	1*	Negative limit switch (software FC-)
	4*	CLEAR input active
	5*	Forward only (Position Modulo)
	8	Activation of the speed modulation
	12*	Minimum Sequence Pulse
	13*	"Inpos" windows
	14*	CAM function
	15	0 trapezoidal profile 1 S-curve profile

Note: * not available on SMT-BD1/p version 506.78

User output PNU : 743

Defines the outputs of bits 8 to 15 of HIW.

Parameter byte

Deadband **PNU :** **744**

Defines the deadband for the position controller. When this parameter is set at 0, the deadband is disabled.

Parameter word

Position modulo **PNU :** **745**

Defines the position after which the position counter is reset at 0. This function allows to get a motor position modulo (only useful for rotating axes).

Parameter double word

Counter position reset (CLEAR input) **PNU :** **746**

This function is released by PNU 742 and allows to reset the position counter at this value when the CLEAR input is activated (this value is generally 0). This function is useful for rotating axes.

Parameter double word

Negative software limit switch **PNU :** **747**

Defines the value of the negative software limit switch which release is defined by PNU 742.

Parameter double word

Positive software limit switch **PNU :** **748**

Defines the value of the positive software limit switch which release is defined by PNU 742.

Parameter double word

2.6 – Encoder output

Encoder output resolutions **PNU :** **750**

Defines the encoder output resolution.

Parameter 1 word: encoder resolution

Limitation The encoder resolution is limited by the maximum application speed.

Max. speed	Max. encoder resolution
100-900	8192
900-3600	4096
3600-14000	1024

Execution With disabled positioner.

Note The encoder output is only effective after the end of the encoder output programming procedure.

Encoder output marker pulse **PNU :** **751, 752, 753**

Parameter Number of encoder pulses (1 - 16).
Phase shift with regard to the resolver marker pulse (0 - 65535).
Marker pulse width (16 - 32767).

Conversion Marker pulse phase shift: 65536 is equivalent to 360°.
Marker pulse width: 65536 is equivalent to 360°.

Limitation Number of encoder pulses: 1 - 16.
Phase shift with regard to the resolver marker pulse: 0 - 65535.
Marker pulse width: 16 - 32767.

Note The positioner takes into account the phase shift value with regard to the resolver marker pulse and the number of marker pulses during the homing procedure.
The encoder output only takes into account these values after the end of the procedure "encoder output programming".

Encoder output programming **PNU :** **754**

This procedure programs the encoder output with the parameters defined above.

Limitation Writing only.

Execution With disabled positioner.

Note The execution of this procedure takes approximately 5 s.

2.7 – Options

Minimum duration SEQ output **PNU :** **756**

Allows to define the minimum duration of the SEQ output. This function is released by PNU 742.

Parameter word

Limitation 0 - 16000 ms

0 means no minimum duration for the SEQ output.

"Inpos" window **PNU :** **757**

Defines a position window in which the INPOS signal is released. This possibility is released by PNU 742.

Parameter double word

CAM position 1 and 2 **PNU :** **758, 759**

Defines the positions between which bit 0 of the outputs (bit 8 of HIW) is activated. This possibility is released by PNU 742.

Parameter double word

2.8 – Manual motion parameters

Manual motion speed **PNU :** **760**

Parameter Speed in rpm.

Limitation 1 - 10000 according to the value of the "Max. speed" parameter.

Note This value depends on the value of the "Max. speed" parameter.

Acceleration ramp in manual motion **PNU :** **761**

Parameter This parameter, defined in ms, corresponds to the acceleration time at max. speed.

Limitation 1 - 16000

Note The minimum value depends on the motor and on the system inertia.

Deceleration ramp in manual motion **PNU :** **762**

Parameter This parameter, defined in ms, corresponds to the deceleration time between max. speed and standstill.

Limitation 1 - 16000

Note The minimum value depends on the motor and on the system inertia.

Speed in jog **PNU :** **763**

Parameter Speed in rpm.

Limitation 1 - 10000 according to the value of the "Max. speed" parameter.

Note This value depends on the value of the "Max. speed" parameter.

Acceleration ramp in jog **PNU :** **764**

Parameter This parameter, defined in ms, corresponds to the acceleration time from standstill up to max. speed.

Limitation 1 - 16000

Note The minimum value depends on the motor and on the system inertia.

Deceleration ramp in jog **PNU :** **765**

Parameter This parameter, defined in ms, corresponds to the deceleration time from max. speed down to standstill.

Limitation 1 - 16000

Note This parameter is also used for emergency stops with programmed braking.

Homing configuration PNU : 766

This parameter defines the configuration of a manual homing.

Parameter	bit	description
	3	Dir
	4	Switch
	5	Zero
	6	Origin
	7	Reset

Note The motion speed and the acceleration and deceleration ramps are those of the manual motion.

Position input command PNU : 767

This parameter defines the position input command for a manual motion in absolute mode (bit 12 of the Control Word) or in relative mode (bit 13 of the Control Word).

Parameter 32 bits

Note This parameter has been created in order to define the position input command if the PPO message used does not contain itself this position input command. Consequently, if a PPO message containing the position input command is used, this input command will replace the value of the input command contained in the PNU 767.

Homing offset PNU : 768

This parameter defines the value that must be taken by the position counter at the end of a manual homing procedure (bit 11 of the Control Word).

Parameter double word

Reading of the logic inputs PNU : 769

This parameter allows the reading of the logic inputs.

Bits	Meaning
0	Software limit switch +
1	Software limit switch -
4	Hardware limit switch +
5	Hardware limit switch -
6	Index
8	ENABLE

Positioner software version PNU : 770

Reading of the positioner software version.

Parameter 32 bits in hexadecimal.

Example Version 506.78 is coded as 0x00050678

Profibus software version PNU : 771

Software version reading of the positioner Profibus interface.

Parameter 16 bits in hexadecimal.

Example Version 3.01 is coded as 0x0301

Positioner error code PNU : 773

Reading of the positioner error code.

Parameter 3 bytes

Byte 1 (low weight):

Bits	Meaning	Descriptions
0		
1	I ² t	I ² t
2	RDC	Resolver converter error
3	POS	Position following error
4	MEM	Memory error
5	BUS	Profibus DP mode error
6		
7	BUSY	Procedure error

Byte 2:

Bits	Meaning	Descriptions
0		
1	POWER	Power stage error
2	RES	Resolver cable interruption error
3	AP	Power undervoltage error
4	ST	Positioner temperature error
	24 V (CD1-p)	24 V error
5	TMOT	Motor temperature error
6	CDG	Watchdog error
7		

Byte 3 (high weight):

Bits	Meaning	Descriptions
0	HOME	Homing procedure timeout error
1	E2PPAR	Parameters EEPROM checksum error
2	E2PSEQ	Sequences EEPROM checksum error
3		
4	SEQWR	Sequence writing error
5		
6		
7		

Motor position PNU : 774

Reading of the motor position.
 Parameter 32 bits

Resolver value PNU : 775

Reading of the value provided by the resolver. This value is an absolute position over one revolution.
 Parameter 16 bits

Speed monitor PNU : 776

Motor speed monitor.
 Parameter integer.
 0x7FFF corresponds to the maximum motor speed.

Current monitor PNU : 777

Motor current monitor.
 Parameter integer.
 0x7FFF corresponds to the maximum current (= rating) in the motor.

Fault code (only on CD1-p) PNU : 778

Extra Error code for CD1-p.
 Parameter word.

Bit 0-2:	2	Power voltage error
	3	Out of 24 Vdc range (18 V to 29 V)
	4	Motor phases/earth short-circuit.
	5	Braking system error
	6	Fan error
	7	Motor holding brake error
Bit 3:		IGBT module error
Bit 4:		Power undervoltage. This error has no influence on the AOK signal
Bit 9:		400 V power stage initialization error
Bit 10:		Power configuration error
Bit 11:		Current measurement offset error
Bit 15:		Current error

2.9 – Sequence Reading/Writing

A sequence is defined by a list of parameters (PNU 782 to PNU 793):

- Sequence control
- Position
- Speed
- Acceleration
- Deceleration
- Delay time
- Link
- Counter
- Counter link
- Condition
- Logic outputs
- Output position

CAUTION !

When the parameter " position resolution " is modified, all position values in the sequences are also modified. When the parameter "Max. motor speed" is modified, all speed parameters in the sequences are modified as well. Consequently, when the sequences parameters are sent to the positioner, it must be previously programmed with the correct parameters "position resolution" and "max. motor speed".

All sequences are saved in the EEPROM. The direct access to a sequence in the EEPROM is not possible. The transfer requires a buffer: the command PNU 780 allows to transfer the EEPROM parameters to the buffer and the command PNU 781 allows to transfer the buffer parameters to the EEPROM. The writing or reading of the buffer parameters are made by the commands PNU 782 to PNU 793.

Reading of a sequence PNU : **780**

Parameter 0-127 sequence number

Note This instruction transfers the sequence parameters from the EEPROM to the buffer. This allows the parameter values to be read in the buffer (see PNU 781).

Writing of a sequence PNU : **781**

Parameter 0-127 sequence number
 128 checksum

Note This instruction transfers the sequence parameters from the buffer to the EEPROM. The sequence parameters must of course be previously written in the buffer (see PNU 780). When all sequences are written, a sequence must be written with a value of 128; this allows to update the checksum in the EEPROM (otherwise, the positioner will indicate an EEPROM fault at its next powering).
 The writing in the EEPROM is not instantaneous; wait at first for the positioner reply before writing other parameters.

All instructions below allow the access to the parameters of the sequence contained in the buffer.

Sequence control **PNU :** **782**

<i>Parameter</i>	bit	description
	0	1 = valid sequence 0 = non valid sequence
	1	0 = positioning 1 = homing
	2	0 = absolute positioning 1 = relative positioning
	3	1 = speed sequence
		If the sequence is a homing (bit 1 = 1), bits 3 to 7 have following meanings:
	3	0 = positive direction 1 = negative direction
	4	0 = without switch 1 = with switch
	5	0 = without marker pulse 1 = with marker pulse
	6	0 = stops the motor after the home position found 1 = positions the motor on the home position
	7	0 = does not reset the position counter 1 = resets the position counter
	8 -11	define the triggering for the logic inputs:
	0	End
	1	Begin
	2	Stop
	3	Speed
	4	Pos
	12-14	reserved.
	15	= 0 conditional start = 1 conditional stop
<i>Note</i>		To invalidate a sequence, just send this instruction with the value 0; the other parameters will be ignored.

Position in the sequence **PNU :** **783**

This parameter defines the position for a positioning (absolute or relative) or the Reset value for a homing.

<i>Parameter</i>	double word
<i>Unit</i>	depends on the position resolution
<i>Variation</i>	(-32768 x resolution) to (32768 x resolution - 1)

Speed in the sequence **PNU :** **784**

Defines the motion speed.

<i>Parameter</i>	word
<i>Unit</i>	rpm
<i>Variation</i>	1 at max. speed for a positioning; can be negative if the sequence is a speed sequence.
<i>Note</i>	This parameter is saved in % with regard to the max. application speed parameter, even if the speed is indicated in rpm. If this parameter is modified, all speed parameters of all sequences must be sent again.

Acceleration in the sequence **PNU :** **785**

This parameter defines the positioning acceleration ramp. For speed sequences, it defines the real acceleration time.

<i>Parameter</i>	word
<i>Unit</i>	ms
<i>Variation</i>	1 to 16000
<i>Note</i>	The real minimum value depends on the motor and the inertia.

Deceleration in the sequence **PNU :** **786**

This parameter defines the positioning deceleration ramp. For speed sequences, it defines the actual deceleration time.

<i>Parameter</i>	word
<i>Unit</i>	ms
<i>Variation</i>	0 to 16000
<i>Note</i>	The real minimum value depends on the motor and the inertia. The value 0 allows to link up to another sequence (parameter Link) without stopping.

Delay / running time		PNU :	787
This parameter defines either:			
	- a delay time at the end of the positioning, for a positioning sequence or,		
	- a movement time at constant speed for a speed sequence or,		
	- the time out for a homing sequence.		
<i>Parameter</i>	word		
<i>Unit</i>	ms for the positioning and speed sequences		
	s for the homing sequences		
<i>Variation</i>	0 to 16000		
Link (next sequence)		PNU :	788
<i>Parameter</i>	0-127	number of the link sequence	
	-1	no link	
Counter		PNU :	789
<i>Parameter</i>	word		
<i>Variation</i>	1 - 32767		
	0	no counter	
	-1	conditional link	
Counter link/conditional jump		PNU :	790
<i>Parameter</i>	0-127	number of the link sequence	
	-1	no link	
<i>Note</i>	For a conditional jump, the counter value must be 0		
Start condition		PNU :	791
This parameter defines the condition inputs for the start of this sequence.			
<i>Parameter</i>	word		
	bit	description	
	0-7	The inputs 0 to 7 must be set at 0.	
	8-15	The inputs 0 to 7 must be set at 1.	
<i>Example</i>	Conditions: bits 1 and 3 = 1		
	bit 6 = 0		
	The value will be 0x0A40		
Programmable logic outputs		PNU :	792
This parameter defines the effect on the logic outputs in this sequence.			
<i>Parameter</i>	word		
	bit	description	
	0-7	mask s for the outputs 0 to 7.	
	8-15	mask r for the outputs 0 to 7.	
	The combination of the s and r masks gives:		
	rs		
	01	->	sets at 1 the corresponding output.
	00	->	sets at 0 the corresponding output.
	10	->	keeps the output unchanged.
	11	->	reverses the output.
<i>Example</i>	If no output is modified, the value is 0xFF00		
Triggering position		PNU :	793
Defines the position that triggers the inputs when the motor passes this position.			
<i>Parameter</i>	double		
<i>Note</i>	This parameter is only effective when the inputs triggering type is a position.		
Torque setpoint		PNU :	794
This parameter defines the torque value as a percentage of the maximum current value.			
<i>Parameter</i>	word		
<i>Unit</i>	%		
<i>Variation</i>	0 to 32767		

Sequence control modification **PNU :** **795**

This parameter directly modifies the sequence control in the RAM. The sequence must be valid. This modification takes effect immediately.

Parameter 16 bits

Index (PKW) Number of the sequence to be modified.

Note This value is not stored in the EEPROM and will consequently be lost at power off. At the next power on, look for the sequence control at the value stored before, by means of the PNU 781 command.

But a sequence control must not be modified during the sequence running.

Position modification in the sequence **PNU :** **796**

This parameter directly modifies the position parameter of a sequence in the RAM; the sequence must be valid. This modification takes effect immediately.

Parameter double word

Index (PKW) number of the sequence to be modified.

Unit depends on the position resolution.

Variation (-32768 x resolution) to (32768 x resolution - 1)

Note This position value is not stored in the EEPROM; consequently, it will be lost at power off. At the next power on, look for the position at the value saved before, by means of command PNU 781. But a sequence position must not be modified during a sequence execution.

Speed modification in the sequence **PNU :** **797**

This parameter directly modifies the speed parameter of a sequence in the RAM; the sequence must be valid. This modification takes effect immediately.

Parameter word

Index (PKW) number of the sequence to be modified.

Unit rpm

Variation 1 to max. speed for a positioning; can be negative if the sequence is a speed sequence.

Notes Eventhough the speed may be given in rpm, this parameter is saved in % with regard to the application maximum speed parameter. If this parameter is modified, all speed parameters of all sequences must be sent again.

This speed value is not stored in the EEPROM. Consequently, it will be lost at power off. At the next power up, find the former saved speed value by command PNU 781.

But a sequence speed must not be modified during the execution.

CD1p only **PNU :** **798**

Modification of a sequence acceleration

This parameter directly modifies the acceleration for a sequence in the RAM. The sequence must be valid. This modification takes effect immediately.

Parameter Word

Index (PKW) Number of the sequence to be modified.

Unit ms

Variation 1 to 16000.

Notes This acceleration value is not stored in the EEPROM. Consequently, it will be lost at power off. At the next power on, look for the acceleration at the value stored before, by means of the PNU 781 command.

But a sequence acceleration must not be modified during the sequence running.

CD1p only **PNU :** **799**

Modification of a sequence deceleration

This parameter directly modifies the deceleration for a sequence in the RAM. The sequence must be valid. This modification takes effect immediately.

Parameter Word

Index (PKW) Number of the sequence to be modified.

Unit ms

Variation 1 to 16000.

Notes This deceleration value is not stored in the EEPROM. Consequently, it will be lost at power off. At the next power on, look for the deceleration at the value stored before, by means of the PNU 781 command.

But a sequence deceleration must not be modified during the sequence running.

CD1p only **PNU :** **800**
Modification of the delay / running time in a sequence

This parameter directly modifies the delay time for a sequence in the RAM. The sequence must be valid. This modification takes effect immediately.

Parameter Word

Index (PKW) Number of the sequence to be modified.

Unit ms

Variation 1 to 16000.

Notes This delay time value is not stored in the EEPROM. Consequently, it will be lost at power off. At the next power on, look for the delay time at the value stored before, by means of the PNU 781 command.

But a sequence delay time must not be modified during the sequence running.

CD1p only **PNU :** **801**
Modification of the link in a sequence (Next sequence)

This parameter directly modifies the link in a sequence in the RAM. The sequence must be valid. This modification takes effect immediately.

Parameter Word

Index (PKW) Number of the sequence to be modified.

Unit

Variation -1 to 127.

Notes This value is not stored in the EEPROM. Consequently, it will be lost at power off. At the next power on, look for the link parameter at the value stored before, by means of the PNU 781 command.

But the link parameter must not be modified during the sequence running.

CD1p only **PNU :** **802**
Modification of the counter in a sequence

This parameter directly modifies the counter value in a sequence in the RAM. The sequence must be valid. This modification takes effect immediately.

Parameter Word

Index (PKW) Number of the sequence to be modified.

Unit

Variation 0 to 16000.

Notes This counter value is not stored in the EEPROM. Consequently, it will be lost at power off. At the next power on, look for the counter parameter at the value stored before, by means of the PNU 781 command.

But the counter parameter must not be modified during the sequence running

CD1p only **PNU :** **803**
Modification of the counter link/conditional jump in a sequence

This parameter directly modifies the counter link in a sequence in the RAM. The sequence must be valid. This modification takes effect immediately.

Parameter Word

Index (PKW) Number of the sequence to be modified.

Unit

Variation -1 to 127.

Notes This value is not stored in the EEPROM. Consequently, it will be lost at power off. At the next power on, look for the counter link parameter at the value stored before, by means of the PNU 781 command.

But the counter link parameter must not be modified during the sequence running.

CD1p only **PNU :** **804**
Modification of the conditional input configuration in a sequence (start condition)

This parameter directly modifies the start condition in a sequence in the RAM. The sequence must be valid. This modification takes effect immediately.

Parameter 16 bits

Index (PKW) Number of the sequence to be modified.

Unit

Variation

Notes This value is not stored in the EEPROM. Consequently, it will be lost at power off. At the next power on, look for the start condition at the value stored before, by means of the PNU 781 command.

But the start condition parameter must not be modified during the sequence running.

CD1p only **PNU :** **805**
Modification of the programmable logic outputs in a sequence

This parameter directly modifies the logic outputs in a sequence in the RAM. The sequence must be valid. This modification takes effect immediately.

Parameter 16 bits

Index (PKW) Number of the sequence to be modified.

Unit

Variation

Notes This value is not stored in the EEPROM. Consequently, it will be lost at power off. At the next power on, look for the logic outputs configuration at the value stored before, by means of the PNU 781 command.

But the logic outputs configuration must not be modified during the sequence running.

CD1p only **PNU :** **806**
Modification of the triggering position in a sequence

This parameter directly modifies the triggering position in a sequence in the RAM. The sequence must be valid. This modification takes effect immediately.

Parameter

Index (PKW) Number of the sequence to be modified.

Unit pt

Variation

Notes This triggering position is not stored in the EEPROM. Consequently, it will be lost at power off. At the next power on, look for the triggering position at the value stored before, by means of the PNU 781 command.

But the triggering position must not be modified during the sequence running.

Modification of the torque setpoint in a sequence **PNU :** **807**

This parameter directly modifies the torque setpoint in a sequence in the RAM. The sequence must be valid. This modification takes effect immediately.

Parameter Word

Index (PKW) Number of the sequence to be modified.

Unit %

Variation

Notes This torque setpoint is not stored in the EEPROM. Consequently, it will be lost at power off. At the next power on, look for the torque setpoint at the value stored before, by means of the PNU 781 command.

But the torque setpoint must not be modified during the sequence running.

The words in brackets in the parameter description correspond to the field pertaining to this parameter in the parameter setting software.

Chapter 6 – Fault finding

1 - DIAGNOSTICS

A fault diagnostic can be made:

- by display: front panel LED display.
- by serial link: clear fault display by the PC parameter setting software.
- by Profibus link: by error code.

At an error triggering, the positioner is disabled.

1.1 - SMT-BD1/p fault LEDs

5 red LEDs are available on the SMT-BD1/p front panel. They are indicating the fault type:

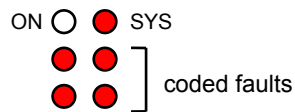

PROTECTION	DISPLAY CODE	LED
Positioner rated current overload: - blinking display = Idyn signal (I^2t threshold is reached) - continuous display = positioner disabled (I^2t fault)	I^2t	● ○ ○ ○
PROFIBUS fault (DP mode)	Profibus	● ○ ○ ●
Position following error	Position	○ ○ ○ ●
Resolver cable interruption	Resolver	○ ● ○ ○
Power stage failure: - power supply overvoltage - internal switch protection - short circuit between phases	Power stage	● ● ○ ○
Resolver converter failure	R.D.C	○ ○ ● ○
Positioner overtemperature	°C Amp.	● ○ ● ○
Power supply undervoltage	Undervolt.	○ ● ● ○
Motor overtemperature	°C Motor	● ● ● ○
Fault of the positioner parameter memory	EEPROM	● ○ ● ●
Positioner automatic procedure: - blinking display = procedure running - continuous display = operating error	Busy	● ● ● ●

○: Led is unlit

● : Led is lit

All these faults are stored in the positioner, except for the "Undervolt." and "Profibus" faults.

1.2 - CD1-p fault LEDs

Only 2 red fault LEDs are available on the CD1-p front panel:

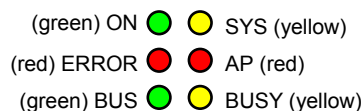

1.3 – Fault reset

The reset of a stored fault can be made:

- via the fault RESET input of X4, pin 13 (only on SMT-BD1/p),
- via the serial link,
- by the control issued from Profibus,
- by switching off the positioner power supply.

2 – FAULT FINDING

2.1 – System fault

If the "SYS" LED is lit at power on, the logic board is defective.

- Check that the EPROM (firmware memory) is correctly plugged on the positioner.
- Check that the EPROM version is actually 50x.x8 on the SMT-BD1/p series and 51x.x8 on the CD1-p series.
- Check for no conducting dust that may involve short-circuits on the positioner logic board.

2.2 – Non stored faults

2.2.1 – Bus fault (Profibus)

This fault is only displayed when the Profibus communication is interrupted. The fault is cancelled as soon as the communication is restored.

2.2.2 - "UNDERVOLT." fault

- If the fault occurs at the positioner commissioning:
 - * Check that the power supply is on.

2.3 – Stored faults

If a fault occurs on the positioner, it can generate the detection of several other faults which are only a consequence of the initial one. In order to make diagnostic and maintenance easier, the faults are displayed and processed with the priority described below. For safety reasons, the power must be turned off for the cancelling of some faults that requires the handling of the positioner; in this case, the RESET is automatic when power is turned on again. If power is not turned off, do not forget to make a RESET immediately after the fault is cancelled.

2.3.1 - "Busy" fault

- If the BUSY fault is continuously displayed after applying power to the positioner, the **AUTOTEST** procedure has failed and the positioner is not ready for operation.
- If the BUSY fault is continuously displayed after the execution of the **AUTOPHASING** function, the procedure has failed because of an external cause and the calculated parameters are wrong. Check that the **ENABLE** input is actually activated. Then check that the motor is unloaded and the shaft movement is free during the procedure.
- If the BUSY fault is continuously displayed after the execution of the **AUTOTUNING** function, the procedure has failed because of an external cause and the calculated parameters are wrong. Check that the **ENABLE** input is actually open. Then check that the motor is unloaded and the shaft movement is free during the procedure.
- This fault may also occur during a homing procedure which "time out" is too low.

2.3.2 - "EEPROM" fault

- Check for the presence of the EEPROM and check its correct orientation.
- If the fault remains, the EEPROM is not correctly initialized (**CHECKSUM**) or is not compatible with the positioner software.
- This fault may occur if the motor is enabled during a parameter saving or during a sequences transfer between PC and positioner.
- To cancel this fault, if it is:
 - * due to the parameters, renew the positioner parameter setting and the parameter saving,
 - * due to the sequences, send the sequences to the positioner again.

2.3.3 - "°C MOTOR" fault

- If the fault occurs when commissioning the positioner:
 - * Check the configuration of the **MN** and **OP** jumpers with regard to the type of thermal switch used in the motor.
 - * Check the connection between the thermal switch and the positioner on the X1 front panel connector or the X6 rack rear connector.
- If the fault occurs during the operation:
 - * Check the motor temperature and look for the reason of this overheating (mechanical shaft overload, duty cycle too high, ...).

2.3.4 - "°C AMP." FAULT

Check for the correct fan type with regard to the rated current required.

2.3.5 - "POWER STAGE" fault

- If the fault occurs at the positioner commissioning:
 - * Check the DC bus voltage and the terminal voltage of the power transformer secondary (DC bus < 370 VDC and V secondary < 260 VAC).
- If the fault occurs during the operation:
 - * Check the braking system operation during the motor braking phases.
 - * Check the sizing of the braking resistor with regard to the motor braking phases.
 - * Check for the correct current cycle required with regard to the current table ([see manuals SMT-BD1/p Installation and CD1-p Installation, Chapter 2, section 1](#)).
 - * Check for no short-circuit in the motor wiring and at the motor terminals.

2.3.6 - "RESOLVER" fault

- Check the resolver connection on the positioner connector X1.
- Check for the presence of the P-RES components.
- Check that the resolver type is correct with regard to the P-RES components ([see chapter 2, section 1](#)).
- Check the connections between the resolver and the positioner and at the resolver terminals.

2.3.7 - "R.D.C." fault

- If the fault occurs at the positioner commissioning:
 - * Check that the values of the P-RES components with regard to the resolver transformation ratio are correct.
- If the fault occurs during the operation:
 - * Check that the motor speed does not exceed the speed limit defined below.
 - If **Maximum speed** ≤ 900 rpm, then the speed limit = 900 rpm.
 - If 900 rpm < **Maximum speed** ≤ 3600 rpm, then the speed limit = 3600 rpm.
 - If 3600 rpm < **Maximum speed** ≤ 14000 rpm, then the speed limit = 14000 rpm.
 - Be careful about the torque mode operation where the motor speed is determined by the load.

2.3.8 - "I²t" fault

- Check the rated current value required with regard to the table of currents authorized in pulse mode cycle.
- Check the rated current of the positioner defined in the **Rated current** parameter with regard to the current required for the operation cycle.

3 – OPERATING PROBLEMS

3.1 – Motor does not move

- Check that the positioner is on.
- Check that the power supply is on.
- Check the positioner fuses (F1 and F2) and the motor connection.
- Check the logic wiring of the signals FC+, FC- and ENABLE.
- Check that the positioner is enabled.

3.2 – Motor supplied but no torque

- Check that the **Maximum current** and **Rated current** parameters have no zero value.

3.3 – Shaft locked, erratic oscillations or rotation at maximum speed

- Check the resolver wiring on the X1 connector and the mechanical mounting of the resolver on the motor.
- Check the value of the motor parameters (number of pole pairs, resolver wiring, motor phase).

3.4 – Discontinuous motor rotation with zero torque positions

- Check the connection of the three phases cables between motor and positioner.

3.5 – Loud crackling noise in the motor at standstill

- Check that the Motor-Positioner-Controller ground connections comply with the recommendations

3.6 – Loud noise in the motor at standstill and when running

- Check the rigidity of the mechanical transmission chain between motor and load (backlash and elasticity in the gearboxes and couplings).
- Execute the **AUTOTUNING** command again by choosing a lower bandwidth (**Medium** or **Low**).

3.7 – Sequence not executed

In "operation enabled" status, the motor does not move at a sequence start in following cases:

- If, after power on, the operator wants to start a positioning sequence whereas sequence 0 is a homing sequence that is not yet executed.
- A start condition has been defined for this sequence and is not fulfilled.
- One or two limit switches activated.

4 - SERVICE AND MAINTENANCE

When exchanging an positioner on a machine, proceed as follows:

- Check that the new positioner has the same hardware configuration as the old positioner (including its address),
- Plug the parameters EEPROM of the old positioner on the new one.

The new positioner is configured like the old one.

Appendix

1 – CURRENT LOOPS ADJUSTMENT (SMT-BD1/p)

For the BL and MA MAVILOR motor series, the current loop adjustments are made by means of the B1, B2, B3 jumpers according to the table below:

MOTOR	POSITIONER	4 A	8 A	12 A	17 A	30 A	45 A	60 A
MA 3			B1					
MA 6			B1	B1				
MA 10			B2	B1	B1	B1		
MA 20			B2	B1	B1	B1	B1	B1
MA 30					B2	B2	B2	B1
MA 45						B2	B2	B1
MA 55							B2	B2
BL 55-3		B1						
BL 55-5		B1						
BL 71			B2					
BL 72			B2	B1	B1			
BL 73			B2	B1	B1			
BL 74			B2	B1	B1			
BL 111			B1	B1				
BL 112			B2	B2	B1	B2		
BL 113			B3	B3	B2	B2	B2	
BL 114					B3	B3	B2	B2
BL 115					B3	B3	B2	B2
BL 141					B2	B2	B2	B1
BL 142					B3	B3	B2	B2
BL 143					B3	B2	B2	B1
BL 144					B2	B2	B2	B1

The adjustment of the current loop P.I. regulators according to the power board current rating and to the motor phase-phase inductance is made as follows:

Calculation of $G = 1,4 \times C \times I$
 with C = current rating (A)
 I = phase-phase inductance (mH),

4 A, 8 A, 12 A AND 17 A POSITIONERS

- If $G < 60$, current loop jumpers (x3) on B3 position,
- If $60 < G < 100$, current loop jumpers (x3) on B2 position,
- If $G > 100$, current loop jumpers (x3) on B1 position.

30 A, 45 A AND 60 A POSITIONERS

- If $G < 100$, current loop jumpers (x3) on B3 position,
- If $100 < G < 250$, current loop jumpers (x3) on B2 position,
- If $G > 250$, current loop jumpers (x3) on B1 position.